

### Overview

### HP ProLiant DL180 Generation9 (Gen9)

The new standard for growing data center needs. Delivering an optimized 2U server, designed with the right balance of expandability, performance, reliability, and manageability—all in a new compact chassis. The ideal platform for SMBs and enterprises running applications, which need the right mix of compute and storage.



### Front View

1. Access Panel ( Top Cover)
2. Power On/Standby button and system power LED
3. Health LED
4. NIC status LED
5. UID button/LED
6. USB 2.0 connector
7. Serial label pull tab
8. Fixed 8-bay SFF drive cage (box 3)
9. 8-bay SFF drive cage bay (box 2, for the second 8-bay SFF drive cage option)
10. HP Media Bay (box 1, for the optical drive cage option)

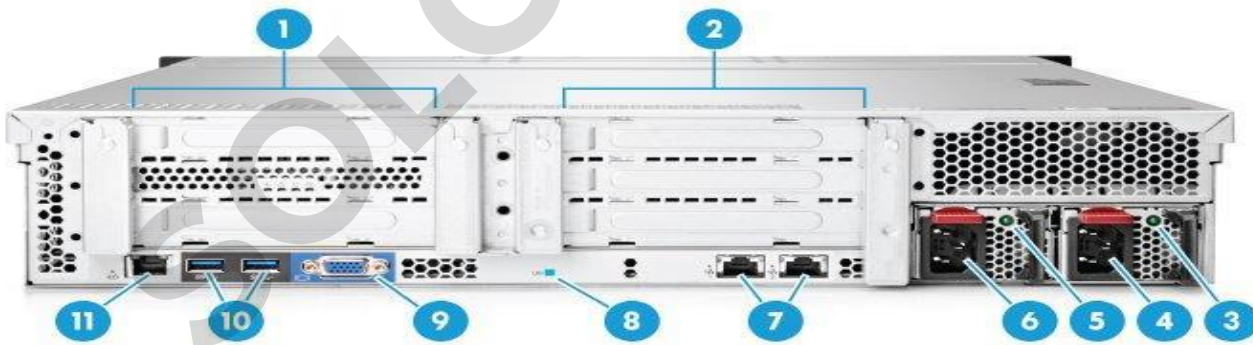

### Rear view

1. PCIe3 slots 1-3 (primary, associated with processor 1)
  2. PCIe3 slots 4-6 (secondary, associated with processor 2)
  3. Power Supply 2 LED (Optional)
  4. Power Supply 2 Power Connector (Optional)
  5. Power Supply 1 LED (Optional)
- NOTE:** RPS shown in the picture.

### Overview

6. Power Supply 1 Power Connector (Optional)
7. NIC connectors
8. UID LED
9. Video Connector
10. USB 3.0 Connectors
11. Dedicated iLO connector (optional)

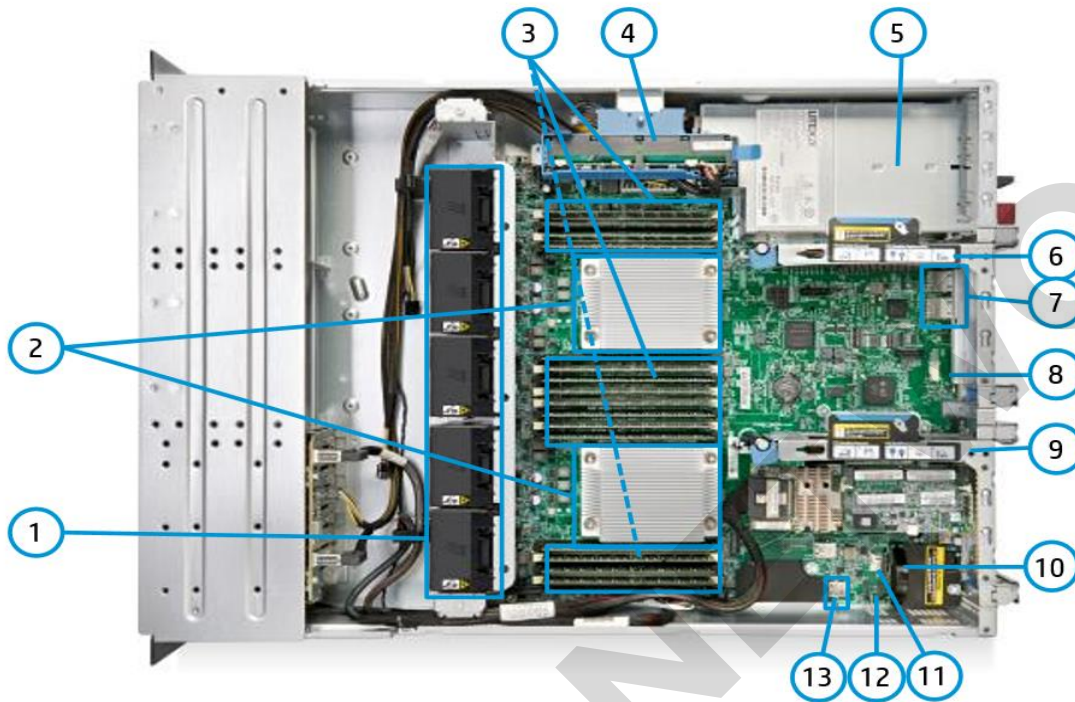

### Internal View

1. Fan cage shown with 5 Hot-swap fans (for 2P Redundancy)
2. 2 Processors, heatsink showing, with HP Smart Socket Guide
3. DDR4 DIMM slots. Shown fully populated in 16 slots (8 per processor)
4. Optional HP Smart Storage Battery
5. Entry level power supply bay (1x900W shown)  
**NOTE: RPS (with one module) shown in the picture above.**
6. Connection for second (optional) riser (Required second CPU)
7. Embedded 2x1GbE NIC
8. Flexible LOM sideband signal connector
9. Primary PCIe riser, standard
10. Dedicated iLO module connector
11. MicroSD card slot
12. SATA optical drive connector
13. Internal USB 3.0 connector (for USB flash devices)

# QuickSpecs

## HP ProLiant DL180 Generation9 (Gen9)

### Standard Features

**NOTE:** For more information regarding Intel Xeon processors, please see the following <http://www.intel.com/xeon>.

Processor	Model	CPU frequency	Cores	L3 Cache	Power	QPI	DDR4 Hz
One of the following depending on model	E5-2660v3	2.6GHz	10	25MB	105W	9.6GT/s	2133
	E5-2650v3	2.3GHz	10	25MB	105W	9.6GT/s	2133
	E5-2650Lv3	1.8GHz	12	30MB	65W	9.6GT/s	2133
	E5-2640v3	2.6GHz	8	20MB	90W	8.0GT/s	1866
	E5-2630v3	2.4Ghz	8	20MB	85W	8.0GT/s	1866
	E5-2630Lv3	1.8GHz	8	20MB	55W	8.0GT/s	1866
	E5-2623v3	3.0GHz	4	10MB	105W	8.0GT/s	1866
	E5-2620v3	2.4GHz	6	15MB	85W	8.0GT/s	1866
	E5-2609v3	1.9GHz	6	15MB	85W	6.4GT/s	1600
	E5-2603v3	1.6GHz	6	15MB	85W	6.4GT/s	1600

**Chipset** Intel® C610 Series Chipset  
 One of the following depending on model Intel® E5-2600v3 Processor Family  
**NOTE:** For more information regarding Intel chipsets, please see the following URL: <http://www.intel.com/products/server/chipsets/>.

**On System Management Chipset** HP iLO (Firmware HP iLO4 2.0) 2GB NAND  
**NOTE:** For more information visit: <http://www.hp.com/go/ilo>.  
 One of the following depending on model

**Memory** Type: HP SmartMemory  
 One of the following depending on model DDR4 Registered (RDIMM) or Load Reduced (LRDIMM)  
 DIMM Slots Available 16 (8 DIMM slots per processor, 4 channels per processor, 2 DIMMs per channel)  
 Maximum Capacity (LRDIMM) 512GB (16 x 32GB LRDIMM @2133MHz)  
 Maximum Capacity (RDIMM) 512GB (16 x 32GB RDIMM @2133MHz)

**Memory Protection** Advanced ECC  
 One of the following depending on Model Online spare  
 Advanced ECC uses single device data correction to detect and correct single and all multibit error that occurs within a single DRAM chip.  
 Memory online spare mode detects a rank that is degrading and switches operation to the spare rank.

**Network Controller** HP 1Gb 361i Ethernet Adapter  
 One of the following depending on model

### Expansion Slots

# QuickSpecs

## HP ProLiant DL180 Generation9 (Gen9)

### Standard Features

Primary Riser (Optional)	Expansion Slots #	Technology	Bus Width	Connector Width	Bus Number	Form Factor	Notes
	1	PCIe 3.0	x8	x8		Full-height, full-length slot	
	2	PCIe 3.0	x8	x8		Full-height, half-length slot	
	3	PCIe 3.0	x8	x8		Full-height, half-length slot	

**NOTE:** Bus Width data indicates the number of physical electrical lanes running to the connector.

Primary Riser (Optional)	Expansion Slots #	Technology	Bus Width	Connector Width	Bus Number	Form Factor	Notes
	1	PCIe 3.0	x16	x16		Full-height, full-length slot	
	2	PCIe 3.0	x8	x8		Full-height, half-length slot	

Riser with Flexible LOM (Optional)	Expansion Slots #	Technology	Bus Width	Connector Width	Bus Number	Form Factor	Notes
	1	PCIe 3.0	x8	x8		Full-height, full-length slot	
	2	PCIe 3.0	x8	x8		Full-height, half-length slot	
	3	Flexible LOM				Full-height, half-length slot	Can only be used for flexibleLOMs

**NOTE:** This riser is mandatory for installing Flexible LOMs & has to be installed in Primary riser slot.

**NOTE:** When populating slots on second riser, a second processor must be installed.

Storage Controller	Entry Models	HP Dynamic Smart Array B140i Controller
One of the following depending on model	<b>NOTE:</b> Provides support for up to 10 SATA drives and data transmission speeds up to 6Gb/s and supports RAID 0, 1 & 5.	
	Base Models	HP Dynamic Smart Array B140i Controller HP H240 FIO Smart Host Bus Adapter
	<b>NOTE:</b> H240 Provides support for up to 8 SAS/SATA drives, data transmission speeds up to 12Gb/s and supports RAID 0, 1 & 5.	
	Storage Models	HP Flexible Smart Array P840/4G FIO Controller
	<b>NOTE:</b> P840 Provides support for up to 16 SAS/SATA drives, data transmission speeds up to 12Gb/s.	
Performance Models	HP Flexible Smart Array P840/4G FIO Controller	
	<b>NOTE:</b> P840 Provides support for up to 16 SAS/SATA drives, data transmission speeds up to 12Gb/s.	

Internal Storage Devices	Optical Drives	Optional: DVD-ROM, DVD-RW <b>NOTE:</b> This option available with all 8SFF drive bay models only.
One of the following depending on model	Hard Drives	None ship standard
	Hard Drive Bays	8 SFF drive bays total with Optical Bay Optional: +8SFF drive bay (total of 16SFF drive bays) <b>NOTE:</b> The Optical Drive bay is not available with +8SFF drive bay optional upgrade.
		8 LFF drive bays total without Optical Bay <b>NOTE:</b> Optical drive is not supported on LFF Chassis.
		12 LFF drive bays total without Optical Bay Up to 4 Non-hot plug SATA 3.5" drives

### Standard Features

Maximum Internal Storage	CAPACITY	CONFIGURATION	
One of the following depending on model	Hot Plug SFF SAS	32TB	16x2TB (with 16SFF drive cage)
	Hot Plug SFF SATA	32TB	16x2TB (with 16SFF drive cage)
	Hot Plug LFF SAS	96.0TB	12x8TB (with 12LFF drive cage)
	Hot Plug LFF SATA	96.0TB	12x8TB (with 12LFF drive cage)
	Hot Plug SFF SAS SSD	30.7TB	16x1.92TB (with 16SFF drive cage)
	Hot Plug SFF SATA SSD	25.6TB	16x1.6TB (with 16SFF drive cage)
	Hot Plug LFF SATA SSD	19.2TB	12x1.6TB (with 12LFF drive cage)
	Non-Hot Plug LFF SATA	32TB	8x4TB (with 8LFF drive cage)

**Power Supply** HP 550W FIO Power Supply  
 One of the following depending on model HP 800W/900W Gold AC Power Input Module

HP Entry-Level Power Supplies provide lower-cost options for customers trying to balance their need for enterprise class efficiency and reliability while maintaining lowest possible hardware costs. All Entry-Level power supply options have been designed specifically for HP ProLiant Gen9 Essential Series servers.

The HP 550W FIO Power Supply is the standard, non-redundant AC power supply option for most HP ProLiant Gen9 Essential servers. It features Silver-level (89%) certified power efficiency with a set of features optimized for the Gen9 Essential-series rack and tower servers.

All pre-configured servers ship with a standard 6-foot IEC C-13/C-14 jumper cord (A0K02A). This jumper cord is also included with each standard AC power supply option kit. If a different power cord is required, please check the [ProLiant Power Cables](#) web page.

To review the power requirements for your selected system, please use the HP Power Advisor Tool located at <http://www.hp.com/go/hppoweradvisor>.

Power specifications and technical content for all HP Server power supplies can be found at <http://www.hp.com/go/proliant/powersupply>.

System Fans	Non-redundant	Redundant
One of the following depending on model		
1P model	2 fans	4 fans
2P model	4 fans	5 fans

**NOTE:** Customers may separately purchase redundant fans with the 725571-B21 option kit. Additional fans (two) are also included in -B21 processor option kits when upgrading from one processor to two processors.

Interfaces	
Video	1 (Vaux Support)
LOM Network Ports	2x1GbE ports
HP iLO Remote Management Network Port	1 GbE (Optional)
SD Slot	1 Micro SD
<b>NOTE:</b> The SD slot is not a hot-pluggable device. Customers should not attempt to plug an SD card into the SD slot while the server is powered.	
USB	Up to 4 USB ports (standard); Front: 1xUSB 2.0 std; (1xUSB3.0 optional upgrade with quick release ears)

### Standard Features

Rear: 2xUSB 3.0  
Internal: 1xUSB 3.0

**NOTE:** 8LFF & 12LFF drive cage models with Quick release latch rack ears supports front USB 3.0.

#### Operating Systems and Virtualization Software Support for ProLiant Servers

Microsoft Windows Server  
Red Hat Enterprise Linux (RHEL)  
SUSE Linux Enterprise Server (SLES)  
Oracle Solaris  
VMware

**NOTE:** For more information on HP's Certified and Supported ProLiant Servers for OS and Virtualization Software and latest listing of software drivers available for your server, please visit our Support Matrix at: <http://www.hp.com/go/ossupport> and our driver download page <http://www.hp.com/support/DL180Gen9>.

#### Upgradeability

Upgradeable to two processors (24 cores)

One of the following depending on model

Up to 16 DIMM slots available

**NOTE:** To take advantage of DIMMs 9-16, a second processor must be installed.

FlexibleLOM slot for 1 Gigabit or 10 Gigabit Ethernet or QDR/FDR InfiniBand networking options

Optional 2 slot riser (x16, x8)

**NOTE:** To take advantage of the additional 2 PCI slot upgrade, a second processor must be installed.

Redundant Power Supply

Redundant Fan

Optical Drive (8 SFF/16 SFF only)

#### Industry Standard Compliance

ACPI 2.0b Compliant

PCIe 3.0 Compliant

PXE Support

WOL Support

Microsoft® Logo certifications

USB 3.0 Support

ASHRAE A3/A4

**NOTE:** Supports A3 & A4 extended ambience.

**NOTE:** Refer to technical specifications section for more details.

#### Graphics

Integrated Matrox G200eH2 video standard

- 1280 x 1024 (32 bpp)
- 1920 x 1200 (16 bpp)

#### HP Server UEFI/Legacy ROM

##### HP Server UEFI /Legacy ROM

Unified Extensible Firmware Interface (UEFI) is an industry standard that provides better manageability and more secured configuration while interacting with your server at boot time. HP ProLiant Gen9 platform defaults to UEFI and can be factory or field configured for Legacy BIOS Boot Mode.

**NOTE:** The UEFI System Utilities function is analogous to the HP ROM-Based Setup Utility (RBSU) of legacy BIOS. For more information, please visit <http://www.hp.com/go/proliantuefi/docs>.

UEFI enables numerous new capabilities specific to HP ProLiant servers such as:

- Secure Boot
- Operating system specific functionality
- Support for > 2.2 TB (using GPT) boot drives

### Standard Features

- USB 3.0 Stack
- Embedded UEFI Shell
- Mass Configuration Deployment Tool using HP RESTful API.
- PXE boot support for IPv6 networks
- Boot support for option cards that only support a UEFI option ROM

For more information please visit <http://www.hp.com/go/proliant/uefi>.

**NOTE:** For UEFI Boot Mode, boot environment and OS image installations should be configured properly to support UEFI.

**NOTE:** HP Legacy FIO Mode Setting (758959-B22) can be selected to configure the system in Legacy mode in the factory.

<b>Form Factor</b>	2U Rack form factor
One of the following depending on model	All models ship with Easy Install rails (Cable management arm optional).
	8 SFF Drive Bay Version: 3.44 (8.75 cm) Height x 17.54" (44.55 cm) Width x 23.9" (60.70 cm) Length
	8 LFF Drive Bay Version: 3.44 (8.75cm) Height x 17.54" (44.55 cm) Width x 23.9" (60.70 cm) Length
	12 LFF Drive Bay Version: 3.44 (8.75cm) Height x 17.54" (44.55 cm) Width x 23.9" (60.70 cm) Length
	16 SFF Drive Bay Version: 3.44 (8.75 cm) Height x 17.54" (44.55 cm) Width x 23.9" (60.70 cm) Length

<b>Embedded Management</b>	<b>HP Integrated Lights-Out (HP iLO)</b>	Monitor your servers for ongoing management, service alerting, reporting and remote management with HP iLO. Learn more at <a href="http://www.hp.com/go/ilo">http://www.hp.com/go/ilo</a> .
	<b>UEFI</b>	Configure and boot your servers securely with industry standard Unified Extensible Firmware Interface (UEFI). Learn more at <a href="http://www.hp.com/go/ProLiant/uefi">http://www.hp.com/go/ProLiant/uefi</a> .
	<b>HP RESTful API</b>	RESTful API is an application programming interface. RESTful Web Service API served by iLO's web server: Learn more at <a href="http://www.hp.com/go/restfulapi">http://www.hp.com/go/restfulapi</a> .
	<b>Intelligent Provisioning</b>	Provision servers by discovering and deploying 1 to few servers with Intelligent Provisioning. Learn more at <a href="http://www.hp.com/go/intelligentprovisioning">http://www.hp.com/go/intelligentprovisioning</a> .
	<b>Embedded Remote Support</b>	HP's embedded remote support, when used with Insight Online direct connect or HP Insight Remote Support, allows HP ProLiant servers to transmit hardware events directly to HP or an HP Authorized Partner for automated phone home support. Learn more at <a href="http://www.hp.com/go/insightonline/info">http://www.hp.com/go/insightonline/info</a> .

<b>Server utilities</b>	<b>HP Smart Update</b>	Optimize firmware and driver updates with HP Smart Update solutions. Learn more at <a href="http://www.hp.com/go/smartupdate">http://www.hp.com/go/smartupdate</a> .
	<b>HP Systems Insight Manager (HP SIM)</b>	HP SIM allows you to monitor the health of your HP ProLiant Servers and HP Integrity Servers, and also provides you with basic support for non-HP servers. HP SIM also integrates with HP SUM to provide quick and seamless firmware updates. Learn more at <a href="http://www.hp.com/go/sim">http://www.hp.com/go/sim</a> .
	<b>HP OneView Standard</b>	HP OneView Standard can inventory, monitor, alert, and report on your G6, G7, Gen8, and Gen9 servers, while using the HP OneView user interface. Annual

## Standard Features

support is optionally available. Learn more at <http://www.hp.com/go/oneview>.

**Scripting Tool Kit  
and Windows  
PowerShell**

Provision 1 to many servers using your own scripts to discover and deploy them with HP Scripting Tool Kit for Windows and Linux or HP Scripting Tools for Windows PowerShell. Learn more at <http://www.hp.com/go/ProLiantSTK> or <http://www.hp.com/go/powershell>.

**HP RESTful  
Interface Tool**

HP RESTful Interface tool is a scripting tool to provision servers using RESTful API Interface to discover and deploy servers at scale. Learn more at <http://www.hp.com/go/restfulapi>.

**HP iLO Mobile  
Application**

Enables the ability to access, deploy, and manage your server anytime from anywhere from select smartphones and mobile devices. For additional information please visit: <http://www.hp.com/go/ilo/mobileapp>.

**HP Insight Online**

HP Insight Online, available at no additional cost as part of your HP warranty, Care Pack or contractual support agreement with HP, is a personalized dashboard for simplified tracking of IT operations and support information from anywhere, anytime. Learn more at <http://www.hp.com/go/insightonline/info>.

---

**Security**

Power-on password  
Serial interface control  
Administrator's password  
TPM 1.2  
UEFI

---

**Warranty**

This product is covered by a global limited warranty and supported by HP Services and a worldwide network of HP Authorized Channel Partners resellers. Hardware diagnostic support and repair is available for three years from date of purchase. Support for software and initial setup is available for 90 days from date of purchase. Enhancements to warranty services are available through HP Care Pack services or customized service agreements. Hard drives have either a one year or three year warranty; refer to the specific hard drive QuickSpecs for details.

**NOTE:** Server Warranty includes 3-Year Parts, 1-Year Labor, 1-Year Onsite support with next business day response. Warranty repairs may be accomplished through the use of Customer Self Repair (CSR) parts. These parts fall into two categories: 1) Mandatory CSR parts are designed for easy replacement. A travel and labor charge will result when customers decline to replace a Mandatory CSR part; 2) Optional CSR parts are also designed for easy replacement but may involve added complexity. Customers may choose to have HP replace Optional CSR parts at no charge. Additional information regarding worldwide limited warranty and technical support is available at: <http://h18004.www1.hp.com/products/servers/platforms/warranty/index.html>.



## Optional Features

<b>Embedded Management</b>	<b>iLO Essentials</b>	HP iLO Essentials is the preferred license for small and medium business that offers full remote server management capabilities for small and medium business via the Integrated Remote Console (IRC), virtual media, and e-mail based alerts. Learn more about HP iLO Essentials at <a href="http://www.hp.com/go/iLO/essentials">http://www.hp.com/go/iLO/essentials</a> .
	<b>iLO Scale-Out</b>	HP iLO Scale-Out is the preferred license built for web hosting, cloud service providers, and high performance computing data centers, managing massive scale out environments. This license offers sophisticated scripting tools that provides remote access through Text Console via SSH, Dynamic power capping, Email-based Alerting and proactive notifications. For more information, visit <a href="http://www.hp.com/go/iLO/scale-out">http://www.hp.com/go/iLO/scale-out</a> .
	<b>iLO Advanced</b>	HP iLO Advanced licenses offer smart remote functionality without compromise, for all HP ProLiant servers. The license includes the full integrated remote console, virtual keyboard, video, and mouse (KVM), multi-user collaboration, console record and replay, and GUI-based and scripted virtual media and virtual folders. You can also activate the enhanced security and power management functionality. Learn more about HP iLO Advanced at <a href="http://www.hp.com/go/ioloadvanced">http://www.hp.com/go/ioloadvanced</a> .
<b>Server Management</b>	<b>HP Insight Control</b>	HP Insight Control, lets you deploy, migrate, monitor, remote control, and optimize your IT infrastructure through a single, simple management console. For more information, see <a href="http://www.hp.com/go/insightcontrol">http://www.hp.com/go/insightcontrol</a> .
	<b>HP OneView Advanced</b>	HP OneView Advanced is converged management that eliminates infrastructure complexity with automation simplicity. This modern architecture is designed to accelerate your IT operations across servers, storage, and network resources using software-defined approaches and automation, see <a href="http://www.hp.com/go/oneview">http://www.hp.com/go/oneview</a> .
<b>Rack and Power Infrastructure</b>	HP Rack and Power Infrastructure products and services create highly efficient and intelligent solutions for existing or new IT data centers. HP Rack and Power infrastructure solutions – rack infrastructure, power protection and management, performance optimized data centers (PODs) – are the foundation you are looking for to help secure your long-term IT success. These products are designed to help you react to changes in the industry. They deliver efficient, easy-to-use capabilities to manage, monitor, deploy and provision infrastructure from entry to enterprise. As an industry leader, HP is uniquely positioned to address the key concerns of power, cooling, cable management and system access. Learn more at <a href="#">HP Rack and Power Infrastructure</a> .	
<b>High Performance Clusters</b>	HP Cluster Platforms are specifically engineered, factory-integrated large-scale ProLiant clusters optimized for High Performance Computing, with a choice of servers, networks and software. Operating system options include specially priced offerings for Red Hat Enterprise Linux and SUSE Linux Enterprise Server, as well as Microsoft Windows HPC Server. A Cluster Platform Configurator simplifies ordering. <a href="http://www.hp.com/go/clusters">http://www.hp.com/go/clusters</a> .	
	HP Insight Cluster Management Utility (CMU) is an HP-licensed and HP-supported suite of tools that are used for lifecycle management of hyperscale clusters of Linux ProLiant systems. CMU includes software for the centralized provisioning, management and monitoring of nodes. CMU makes the administration of clusters user friendly, efficient, and effective. <a href="http://www.hp.com/go/cmu">http://www.hp.com/go/cmu</a> . <b>NOTE:</b> High Performance Computing (HPC) interconnect technologies are available for this server as part of the HP Cluster Platform portfolio. These high-speed InfiniBand and Gigabit interconnects are fully supported by HP when integrated within an HP cluster. Flexible, validated solutions can be defined with the help of configuration tools. <a href="http://www.hp.com/techservers/clusters/ucp/index.html">http://www.hp.com/techservers/clusters/ucp/index.html</a> .	
<b>HPC Interconnects</b>	<b>NOTE:</b> High Performance Computing (HPC) interconnect technologies are available for this server under the HP Cluster Platform product portfolio. These high-speed interconnects are fully supported by HP	

### Optional Features

when they are part of these configure to order clusters. Solutions can be defined with a lot of flexibility with the help of configuration tools. Please visit the following URL to configure HPC Clusters with InfiniBand Interconnects: <http://www.hp.com/techservers/clusters/ucp/index.html>.

#### Storage Software

Whether you need to solve a specific data protection, archiving, or storage command and control challenge, or deliver on strategic consolidation, compliance, or continuity initiatives, look no further than HP storage software. Our storage software helps you reduce costs, simplify storage infrastructure, protect vital assets and respond faster to business opportunities.

Storage software that gets the job done:

- **Data Protection and Recovery Software**  
Whether you're a large enterprise or a smaller business, HP data protection and recovery software will cost-effectively protect you against disaster and ensure business continuity.
- **Data Archive and Migration Software**  
HP's storage software enables you to comply with data retention and retrieval requirements, improve application performance, and reduce costs by efficiently migrating infrequently accessed or less valuable data to lower cost storage.
- **Storage Resource Management Software (SRM)**  
HP's storage resource management software reduces operational costs and provides the command and control foundation you need to efficiently manage and visualize your physical and virtual environments.
- **Data Replication Software**  
HP offers array-based and host-based replication software for use in disaster recovery, testing, application development and reporting.
- **Storage Device Management Software**  
Maximize your investment in HP storage and networking with software that enables hardware-specific configuration, performance tuning and connectivity management.
- **HP StoreVirtual VSA**  
With HP StoreVirtual VSA you can use the power of virtualization to create a virtual array within your host server. Manage it as a single pool of shared storage capacity, and scale it to match your evolving needs. HP ProLiant Gen9 servers include a 3-year limited license for HP StoreVirtual VSA software with 1TB of capacity at no extra cost. Simply select to install HP StoreVirtual VSA software during server setup within Intelligent Provisioning. More information, instructional videos, and free console management software are available at <http://www.hp.com/go/vsa1TB>.

**NOTE:** For more information about Storage Software including QuickSpecs, please see: <http://www.hp.com/go/storage/software>.

#### One Config Simple (SCE)

SCE is a guided self-service tool to help sales and non-technical people provide customers with initial configurations in 3 to 5 minutes. You may then send the configuration on for configuration help, or use in your existing ordering processes. If you require "custom" rack configuration or configuration for products not available in SCE, please contact HP's Customer Business Center or an Authorized Partner for assistance. <http://www.hp.com/products/configurator>.

**Service and Support****Service and Support****HP Technology Services for Industry Standard Servers**

HP Technology Services delivers confidence, reduces risk and helps customers realize agility and stability. Connect to HP to help prevent problems and solve issues faster. Our support technology lets you to tap into the knowledge of millions of devices and thousands of experts to stay informed and in control, anywhere, any time.

**Protect your business beyond warranty with HP Care Pack Services**

HP Care Pack Services enable you to order the right service level, length of coverage and response time as you purchase your new server, giving you full entitlement for the term you select.

**Optimized Care****Supports maintaining servers at optimum performance availability****HP Proactive Care with 24x7 coverage, three year Care Pack Service**

HP Proactive Care helps prevent problems and stabilize IT by utilizing secure, real-time, predictive analytics and proactive consultations when your products are connected to HP. This Care Pack Service combines three years' proactive reporting and advice with our 24x7 coverage and enhanced escalation management, four hour hardware response time and two hour call back for software questions on leading industry standard software running on your HP ProLiant server.

<http://h20195.www2.hp.com/v2/GetPDF.aspx/4AA3-8855ENW.pdf>

**Standard Care Package****Supports maintaining high level of server availability****Foundation Care 24x7, three-year Care Pack Service**

HP Foundation Care 24x7 connects you to HP 24 hours a day, seven days a week for assistance on resolving issues. Hardware onsite response within four hours if needed; collaborative software included in this Care Pack service provides troubleshooting assistance on industry leading software running on your HP server. Simplify your support experience and make HP your first call for hardware or software questions.

<http://h20195.www2.hp.com/V2/GetDocument.aspx?docname=4AA4-8876ENW&cc=us&lc=en>

**Related Services****HP ProLiant Server Hardware Installation**

Provides for the basic hardware installation of HP branded servers, storage devices and networking options to assist you in bringing your new hardware into operation in a timely and professional manner.

<http://h20195.www2.hp.com/V2/GetPDF.aspx/5981-9356EN.pdf>

**Factory Express for Servers and storage**

HP Factory Express offers configuration, customization, integration and deployment services for HP servers and storage products. Customers can choose how their factory solutions are built, tested, integrated, shipped and deployed. For more information on Factory Express services for your specific server model please contact your sales representative or go to: <http://www.hp.com/go/factory-express>.

**Data Privacy Services**

Protect your data through better media management. HP Data privacy services help manage and protect sensitive data to reduce the risk of unauthorized access to private information and help meet compliance requirements. Our retention services allow you to keep drives and other devices upon failure, our removal services provide convenient data sanitization and our recovery services allow you to safely retire IT assets and capture any remaining value from the hardware. <http://www.hp.com/services/dataprivacy>

Additional HP Care Pack services can be found at: <http://www.hp.com/go/cpc>

**Get connected to HP to improve your support experience**

Prevent problems with innovative, automated monitoring tools and proactive services. Combining Proactive Care Services with our remote support technology such as Insight Online provides you with expert advice and personalized, cloud-based automated IT support, helping to prevent unplanned down time and solve problems quickly. For more information, visit: <http://www.hp.com/go/proactiveinsightexperience>

### Service and Support

**HP Support Center** Personalized online support portal with access to information, tools and experts to support HP business products. Submit support cases online, chat with HP experts, access support resources or collaborate with peers. Learn more <http://www.hp.com/go/hpsc>

HP's Support Center Mobile App\*\* allows you to resolve issues yourself or quickly connect to an agent for live support. Now, you can get access to personalized IT support anywhere, anytime. HP Insight Remote Support and HP Support Center are available at no additional cost with a HP warranty, HP Care Pack or HP contractual support agreement.

\*\* HP Support Center Mobile App is subject to local availability.

---

### Parts and Materials

HP will provide HP-supported replacement parts and materials necessary to maintain the covered hardware product in operating condition, including parts and materials for available and recommended engineering improvements.

Parts and components that have reached their maximum supported lifetime and/or the maximum usage limitations as set forth in the manufacturer's operating manual, product quick-specs, or the technical product data sheet will not be provided, repaired, or replaced as part of these services.

The defective media retention service feature option applies only to Disk or eligible SSD/Flash Drives replaced by HP due to malfunction.

---

### For more information

To learn more on HP ProLiant servers, please contact your HP sales representative or HP Authorized Channel Partner or visit: <http://www.hp.com/services/proliant>

### Pre-configured Models

For the Standard Features shipped in the "Factory Integrated Models", please see the "Configuration Information - Factory Integrated Models" section.

1. Pre-configured models ship with the configurations below. Options can be selected from the Core or Additional options section of this QuickSpecs.
2. HP does not allow factory integration of options into pre-configured models. Any additional options purchased will be shipped separately.
3. If you desire a custom configuration please see "Configuration Information - Factory Integrated Models" section of this QuickSpecs.
4. Not all models are available in all regions. Check with your local country HP offices for availability.

**NOTE:** All Pre-configured Models come populated with some hard drive blanks installed. Should the customer need additional hard drive blanks, they can order more using either P/N 666987-B21: HP SFF Hard Drive Blank Kit or P/N 666986-B21: HP LFF Hard Drive Blank Kit.

**NOTE:** All pre-configured servers ship with a standard 6-foot IEC C-13/C-14 jumper cord (AOK02A). This jumper cord is also included with each standard AC power supply option kit. If a different power cord is required, please check the [ProLiant Power Cables](#) web page.

**Caution:** HP recommends that a minimum of two people are required for all Rack Server installations. Please refer to your installation instructions for proper tools and number of people to use for any installation.

	Entry Models		Base Models	
<b>[SKU Number]</b>	778452-B21	778453-B21	778454-B21	778455-B21
<b>Model Name</b>	HP ProLiant DL180 Gen9 E5-2603v3 1P 8GB-R B140i 4LFF NHP SATA 550W PS Entry Server	HP ProLiant DL180 Gen9 E5-2603v3 1P 8GB-R B140i 8LFF Hot Plug SATA 550W PS Entry Server	HP ProLiant DL180 Gen9 E5-2609v3 1P 8GB-R H240 8LFF SAS 550W PS Base Server	HP ProLiant DL180 Gen9 E5-2609v3 1P 8GB-R H240 8SFF SAS 550W PS Base Server
<b>Processor</b>	Intel® Xeon® E5-2603v3		Intel® Xeon® E5-2609v3	
<b>Number of Processors</b>	One			
<b>Memory</b>	8GB (1x8GB Registered DIMMs, 2133 MHz) <b>NOTE: Due to processor limitation, these DDR4 DIMMs will operate at 1600 MHz in this model.</b>			
<b>Network Controller</b>	HP Ethernet 1Gb 2-port i350 Adapter			
<b>Storage Controller</b>	HP Dynamic Smart Array B140i		HP H240 FIO Smart Host Bus Adapter	
<b>Hard Drive</b>	None ship standard; includes 4 LFF hard drive blanks	None ship standard; includes 6 LFF hard drive blanks		None ship standard; includes 6 SFF hard drive blanks
<b>Internal Storage</b>	4 LFF HDD Bays (Non Hot Plug)	8 LFF HDD Bays		8 SFF HDD Bays
<b>Optical Drive Bay</b>	Not Available			1; (Optional: DVD-ROM, DVD-RW)
<b>PCI-Express Slots</b>	3 Standard (1-FL/FH, 2-FH/HL)			
<b>Power Supply</b>	(1) HP 550W FIO Power Supply			
<b>Fans</b>	2 hot swap fans, non-redundant			
<b>Management</b>	iLO Management (standard), Intelligent Provisioning (standard), iLO Essentials (optional)			
<b>Form Factor</b>	Rack (2U), HP Easy Install Rails			
<b>Warranty</b>	Server Warranty includes 3-Year Parts, 1-Year Labor, 1-Year Onsite support with next business day response.			

# QuickSpecs

## HP ProLiant DL180 Generation9 (Gen9)

### Pre-configured Models

	Storage Models	Energy Star Models
<b>[SKU Number]</b>	778456-B21	778457-B21
<b>Model Name</b>	HP ProLiant DL180 Gen9 E5-2623v3 1P 16GB-R P840 12LFF SAS 900W PS Storage Server	HP ProLiant DL180 Gen9 E5-2630v3 2P 32GB-R P840/4G 16SFF SAS 800W RPS ES Server
<b>Processor</b>	Intel® Xeon® E5-2623v3	Intel® Xeon® E5-2630v3
<b>Number of Processors</b>	One	Two
<b>Memory</b>	16GB (2x8GB Registered DIMMs, 2133 MHz)	32GB (2x16GB Registered DIMMs, 2133 MHz)
<b>Network Controller</b>	HP Ethernet 1Gb 2-port i350 Adapter	
<b>Storage Controller</b>	HP Flexible Smart Array P840/4G FIO Controller	
<b>Hard Drive</b>	None ship standard	
<b>Internal Storage</b>	12 LFF HDD Bays	16 SFF HDD Bays
<b>Optical Drive Bay</b>	Not Available	1; (Optional: DVD-ROM, DVD-RW)
<b>PCI-Express Slots</b>	3 Standard (1-FL/FH, 2-FH/HL)	
<b>Power Supply</b>	(1) HP 900W Redundant Power Supply	(2) HP 900W Redundant Power Supply
<b>Fans</b>	4 hot plug fans, redundant	5 hot plug fans, redundant
<b>Management</b>	iLO Management (standard), Intelligent Provisioning (standard), iLO Essentials (optional)	
<b>Energy Star</b>	Meets Energy Star requirements	
<b>Form Factor</b>	Rack (2U), HP Easy Install Rails	Rack (2U), HP Easy Install Rails with CMA
<b>Warranty</b>	Server Warranty includes 3-Year Parts, 1-Year Labor, 1-Year Onsite support with next business day response.	

#### Country Code Key

xx1 = B21

Worldwide

**NOTE:** The -B21 WW SKU is to be ordered in all countries other than Japan or PRC.

xx1 = 291

Japan

xx1 = AA1

PRC

### Configuration Information - Factory Integrated Models

This section lists some of the steps required to configure a Factory Integrated Model. To ensure only valid configurations are ordered, HP recommends the use of an HP approved configurator. Contact your local sales representative for information on configurable product offerings and requirements.

1. Factory Integrated Models must start with a CTO Server.
2. FIO indicates that this option is only available as a factory installable option.
3. All Factory Integrated Models will be populated with sufficient hard drive blanks based on the number of initial hard drives ordered with the server.
4. Some options may not be integrated at the factory. Contact your local sales representative for additional information.

### Step 1: Base Configuration (choose one of the following configurable models)

<b>[Chassis]</b>	HP ProLiant DL180 Gen9 Non-hot Plug LFF Configure-to-order Server	HP ProLiant DL180 Gen9 Hot Plug 8LFF Configure-to-order Server	HP ProLiant DL180 Gen9 Hot Plug 8SFF Configure-to-order Server	HP ProLiant DL180 Gen9 Hot Plug 12LFF Configure-to-order Server
<b>SKU Number</b>	754525-B21	754524-B21	754523-B21	775506-B21
<b>Processor</b>	2 (optional) x HP Smart Socket Guide			
<b>DIMM Slots</b>	16 DIMM slots for RDIMM, LRDIMM DDR4 Memory			
<b>Storage Controller</b>	HP Dynamic Smart Array B140i			
<b>PCIe</b>	3 PCIe slots (+3 PCI slots available with upgrade option, second processor required)			
<b>Drive Cage</b>	4LFF or 8LFF Non Hot Plug	8LFF Hot Plug (+4LFF optional field upgradable)	8SFF Hot Plug (+8SFF Optional)	12LFF Hot Plug
<b>Network Controller</b>	HP Ethernet 1Gb 2-port i350 Adapter			
<b>Fans</b>	2 hot swap fans, non-redundant			
<b>Management</b>	iLO Management (standard), Intelligent Provisioning (standard), iLO Essentials (optional)			
<b>USB</b>	1 front, 1 internal, 2 rear			
<b>Ears</b>	Optional	HP Quick Release Ears	Optional	HP Quick Release Ears

**NOTE:** HP ProLiant DL180 Gen9 Non-hot plug chassis (P/N- 754525-B21) supports both 4LFF and 8LFF configurations.

**NOTE:** Thumb screw ears are not supported on Hot Plug LFF Chassis.

### Step 2: Choose Required Options (only one of the following from each list unless otherwise noted)

#### HP Processors

Select one or two processors from Core options-Processor section below.

- If one processor is desired, select one xxxxxx-L21
- If two processors are desired, select one xxxxxx-L21 and one xxxxxx-B21.
- Up to 2 processors supported. Mixing different processor models is not supported.
- DDR4 speed is the maximum memory speed of the processor. Actual memory speed may depend on the quantity and type of DIMMs installed.

For the Intel® C600 Chipset E5-2600 Series, the letter preceding the model number indicates the Product Line (E3, E5, E7); 2600x v#, 2 = number of CPUs in a Node, 6 is socket/segment designation, 00 = Processor SKU, x = L for low power SKUs and v# (not yet designated) = version number.

#### HP Memory

Select one or more memory from Core options-Memory section below.

- LRDIMM, RDIMM are all distinct memory technologies and cannot be mixed within a server. The majority of ProLiant Gen9 servers support LRDIMM and RDIMM.
- HP memory from previous generation servers are not qualified or warranted with this HP ProLiant Server. HP SmartMemory is required to realize the memory performance improvements and enhanced functionality listed in this document for Gen9.

### Configuration Information - Factory Integrated Models

- If only one processor is installed, only half of the total DIMM slots are available. When populating with two processors all DIMM slots are available.
- Kits described as LP include Low Power DIMMs. For more information on ProLiant Energy Efficient Features, see: <http://www.hp.com/go/proliant-energy-efficient>.
- Depending on the memory configuration and processor model, the memory speed may run at 2133MHz, 1866MHz, 1600MHz or 1333MHz. Please see Memory Population Table or the Online Memory Configuration Tool at: <http://www.hp.com/go/ddr4config>.

#### Power Supplies - 100 series servers

Select one or more power supplies from Core Options-Power Supplies section below.

- Prior to selecting a power supply option, it is highly recommended that you review your server configuration in the HP Power Advisor tool to determine the right size power supply for your server configuration. The HP Power Advisor is located at: <http://www.hp.com/go/hppoweradvisor>.
- By RPS Enablement Kit power options, mixing of power supplies in the same RPS enablement kit is not supported. All power supplies must be of the same input voltage, output rating, and efficiency rating. If non-matching power supplies are installed, you may receive an error message and/or experience operational issues with your server.

### Step 3: Choose Additional Factory Integratable Options

**HP Unique Options** Select one or more Unique options from Core options section below.

- This section may contain FIO options, please see the Unique options section below.
- FIO indicates that this option is only available as a factory installable option.

#### HP Drives

Select one or more drives from Core options-HP Drives section below.

- The components of a storage subsystem (e.g. the drive, the HBA/controller, firmware, and the server backplane) should operate at the same data transfer rate or the system bandwidth will be negotiated down to an acceptable level for all components.
- Hard drives have either a one year or three year warranty; refer to the specific hard drive QuickSpecs for details.
- The HP ProLiant Gen9 Smart Storage solutions are equipped with re-designed Small Form Factor (SFF 2.5 in) and Large Form Factor (LFF 3.5 in) hot plug carriers for HP Qualified Hard Drives and Solid State Drives. These new carriers provide status and activity indicators as well as caution indicators for "Do Not Remove".

#### HP Flexible LOM

Select a FlexibleLOM from Core options-Networking section below.

- Only one FlexibleLOM can be added to the server. These options are upgradeable and can be changed from the original configuration after the server is shipped.
- For 10Gb adapters, a minimum of two Gigabytes (2 GB) of server memory is required per each adapter.
- Please see the QuickSpecs for Technical Specifications and additional information: <http://www.hp.com/go/ProLiantNICs>.

#### HP Networking

Select a standup NIC adapter from Core options-Networking section below.

- Please see the QuickSpecs for Technical Specifications and additional information: <http://www.hp.com/go/ProLiantNICs>.
- These options are upgradeable and can be changed from the original configuration after the server is shipped.
- For 10Gb adapters, a minimum of two Gigabytes (2 GB) of server memory is required per each adapter.



### Configuration Information - Factory Integrated Models

#### HP Graphics Options

Select one or more graphics adapter from Additional options section below.

- Please see the HP Power Advisor for estimated power consumption of your individual system configuration prior to installing GPUs. The HP Power Advisor is located at: <http://www.hp.com/go/hppoweradvisor>.
- This section may contain FIO options, please see HP Computation & Graphics Accelerators section below.

**HP Cooling Options** Select one or more Fan Kits from Core options section below.

- This section may contain FIO options, please see HP Cooling Options section below.
- FIO indicates that this option is only available as a factory installable option.

#### HP Storage Controllers

Select one or more Storage options from Additional options section below.

- The embedded B140i controller will operate in UEFI only mode. For legacy support an additional controller will be needed, and for CTO orders please also select the Legacy mode settings part, 758959-B22
- This section may contain FIO options, please see HP Storage Controllers section below.
- FIO indicates that this option is only available as a factory installable option.

#### HP I/O Expansion Options

Select one or more Riser Kit options from Core options section below.

- To take advantage of the additional PCI slot upgrade, the second processor must be installed.
- This section may contain FIO options, please see HP I/O Expansion Options section below.
- FIO indicates that this option is only available as a factory installable option.

#### HP Rail Kits

Select one type of rail kit from Additional options section below.

- Please take a moment to review the installation documentation that comes with the server to help you with the installation of your Gen9 server.
- To assist in the installation of the server into the rack, an optional installation tool is available by contacting your local services representative (p/n 695539-001).
- See HP Rack Options in Additional Options section of this QuickSpecs for more rack kit choices.

**Caution:** HP recommends that a minimum of two people are required for all Rack Server installations. Please refer to your installation instructions for proper tools and number of people to use for any installation.

## Core Options

**NOTE:** Some options may not be integrated at the factory. To ensure only valid configurations are ordered, HP recommends the use of an HP approved configurator. Contact your local sales representative for additional information.

<b>HP Unique Options</b>	HP DL180 Gen9 Dedicated iLO Management Port Kit	725581-B21
	HP DL180 Gen9 8SFF Hard Drive Cage/Backplane Kit	725572-B21
	HP DL180 Gen9 12LFF Hot Plug Enablement Kit	725574-B21
	<b>NOTE:</b> This can be used only with 8LFF Hot Plug Chassis and contains the controller cables required for upgrade.	
	HP DL180 Gen9 3 Slot x8 PCI-E Riser Kit	725569-B21
	HP DL180 Gen9 x16 PCI-E Riser Kit	725570-B21
	HP Quick-release Latch Rack Ears FIO Kit	725579-B21
	<b>NOTE:</b> This option kit is required for Security Bezel. This option also provides one front USB 3.0 upgrade.	
	HP AHCI-Enable FIO Setting	801845-B21
	<b>NOTE:</b> This needs to be selected when Advanced Host Controller Interface mode is required with B140i controller.	

## HP Processors

**Entry Processors - E5-2600v3 series Processors**

HP DL180 Gen9 Intel® Xeon® E5-2609v3 (1.9GHz/6-core/15MB/85W) Processor Kit	733925-B21
HP DL180 Gen9 Intel® Xeon® E5-2609v3 (1.9GHz/6-core/15MB/85W) FIO Processor Kit	733925-L21
HP DL180 Gen9 Intel® Xeon® E5-2603v3 (1.6GHz/6-core/15MB/85W) Processor Kit	733929-B21
HP DL180 Gen9 Intel® Xeon® E5-2603v3 (1.6GHz/6-core/15MB/85W) FIO Processor Kit	733929-L21

**Base Processors - E5-2600v3 series Processors**

HP DL180 Gen9 Intel® Xeon® E5-2640v3 (2.6GHz/8-core/20MB/90W) Processor Kit	733916-B21
HP DL180 Gen9 Intel® Xeon® E5-2640v3 (2.6GHz/8-core/20MB/90W) FIO Processor Kit	733916-L21
HP DL180 Gen9 Intel® Xeon® E5-2630v3 (2.4GHz/8-core/20MB/85W) Processor Kit	733918-B21
HP DL180 Gen9 Intel® Xeon® E5-2630v3 (2.4GHz/8-core/20MB/85W) FIO Processor Kit	733918-L21
HP DL180 Gen9 Intel® Xeon® E5-2630Lv3 (1.8GHz/8-core/20MB/55W) Processor Kit	763226-B21
HP DL180 Gen9 Intel® Xeon® E5-2630Lv3 (1.8GHz/8-core/20MB/55W) FIO Processor Kit	763226-L21
HP DL180 Gen9 Intel® Xeon® E5-2620v3 (2.4GHz/6-core/15MB/85W) FIO Processor Kit	733921-L21
HP DL180 Gen9 Intel® Xeon® E5-2620v3 (2.4GHz/6-core/15MB/85W) Processor Kit	733921-B21
HP DL180 Gen9 Intel® Xeon® E5-2623v3 (3GHz/4-core/10MB/105W) Processor Kit	779830-B21
HP DL180 Gen9 Intel® Xeon® E5-2623v3 (3GHz/4-core/10MB/105W) FIO Processor Kit	779830-L21

**Performance Processors - E5-2600v3 series Processors**

HP DL180 Gen9 Intel® Xeon® E5-2660v3 (2.6GHz/10-core/25MB/105W) Processor Kit	733912-B21
HP DL180 Gen9 Intel® Xeon® E5-2660v3 (2.6GHz/10-core/25MB/105W) FIO Processor Kit	733912-L21

## Core Options

HP DL180 Gen9 Intel® Xeon® E5-2650v3 (2.3GHz/10-core/25MB/105W) Processor Kit	733914-B21
HP DL180 Gen9 Intel® Xeon® E5-2650v3 (2.3GHz/10-core/25MB/105W) FIO Processor Kit	733914-L21
HP DL180 Gen9 Intel® Xeon® E5-2650Lv3 (1.8GHz/12-core/30MB/65W) Processor Kit	763222-B21
HP DL180 Gen9 Intel® Xeon® E5-2650Lv3 (1.8GHz/12-core/30MB/65W) FIO Processor Kit	763222-L21

## HP Memory

**Registered DIMMs (RDIMMs) for E5-2600v3 Series**

HP 4GB (1x4GB) Single Rank x8 DDR4-2133 CAS-15-15-15 Registered Memory Kit	726717-B21
HP 8GB (1x8GB) Single Rank x4 DDR4-2133 CAS-15-15-15 Registered Memory Kit	726718-B21
HP 8GB (1x8GB) Dual Rank x8 DDR4-2133 CAS-15-15-15 Registered Memory Kit	759934-B21
HP 16GB (1x16GB) Dual Rank x4 DDR4-2133 CAS-15-15-15 Registered Memory Kit	726719-B21
HP 32GB (1x32GB) Dual Rank x4 DDR4-2133 CAS-15-15-15 Registered Memory Kit	728629-B21

**Load Reduced DIMMs (LRDIMMs) for E5-2600v3 Series**

HP 16GB (1x16GB) Dual Rank x4 DDR4-2133 CAS-15-15-15 Load Reduced Memory Kit	726720-B21
HP 32GB (1x32GB) Quad Rank x4 DDR4-2133 CAS-15-15-15 Load Reduced Memory Kit	726722-B21

**HP Standard Memory**

HP 4GB (1x4GB) Single Rank x8 DDR4-2133 CAS-15-15-15 Registered Standard Memory Kit	803026-B21
HP 8GB (1x8GB) Single Rank x4 DDR4-2133 CAS-15-15-15 Registered Standard Memory Kit	803028-B21

**NOTE:** These memory options are available as standalone only and can not be configured in the factory. These are standard memory DIMMs with no Smart Memory features.

## HP Optical Drives

HP DL180 Gen9 Optical Disk Drive Enablement Kit	725582-B21
HP 9.5mm SATA DVD-ROM JackBlack Gen9 Optical Drive	726536-B21
HP 9.5mm SATA DVD-RW JackBlack G9 Optical Drive	726537-B21
HP Mobile USB Non Leaded System DVD RW Drive	701498-B21

**NOTE:** Optical drive is not supported on LFF models.

## HP Drives

**SAS Hot Plug SFF (2.5-inch) Enterprise (ENT) Drives**

HP 1.8TB 12G SAS 10K rpm SFF (2.5-inch) SC Enterprise 512e 3yr Warranty Hard Drive	791034-B21
HP 1.2TB 12G SAS 10K rpm SFF (2.5-inch) SC Enterprise 3yr Warranty Hard Drive	781518-B21
HP 1.2TB 6G SAS 10K rpm SFF (2.5-inch) SC Dual Port Enterprise 3yr Warranty Hard Drive	718162-B21
HP 900GB 12G SAS 10K rpm SFF (2.5-inch) SC Enterprise 3yr Warranty Hard Drive	785069-B21
HP 900GB 6G SAS 10K rpm SFF (2.5-inch) SC Enterprise 3yr Warranty Hard Drive	652589-B21
HP 600GB 12G SAS 15K rpm SFF (2.5-inch) SC 512e Enterprise 3yr Warranty Hard Drive	748387-B21
HP 600GB 12G SAS 15K rpm SFF (2.5-inch) SC Enterprise 3yr Warranty Hard Drive	759212-B21
HP 600GB 12G SAS 10K rpm SFF (2.5-inch) SC Enterprise 3yr Warranty Hard Drive	781516-B21

**Core Options**

HP 600GB 6G SAS 10K rpm SFF (2.5-inch) SC Enterprise 3yr Warranty Hard Drive	652583-B21
HP 450GB 12G SAS 15K rpm SFF (2.5-inch) SC Enterprise 3yr Warranty Hard Drive	759210-B21
HP 450GB 6G SAS 10K rpm SFF (2.5-inch) SC Enterprise 3yr Warranty Hard Drive	652572-B21
HP 300GB 12G SAS 15K rpm SFF (2.5-inch) SC Enterprise 3yr Warranty Hard Drive	759208-B21
HP 300GB 12G SAS 10K rpm SFF (2.5-inch) SC Enterprise 3yr Warranty Hard Drive	785067-B21
HP 300GB 6G SAS 10K rpm SFF (2.5-inch) SC Enterprise 3yr Warranty Hard Drive	652564-B21
HP 146GB 6G SAS 15K rpm SFF (2.5-inch) SC Enterprise 3yr Warranty Hard Drive	652605-B21
<b>SAS Hot Plug SFF (2.5-inch) Midline (MDL) Drives</b>	
HP 2TB 12G SAS 7.2K rpm SFF (2.5-inch) SC 512e 1yr Warranty Hard Drive	765466-B21
HP 1TB 12G SAS 7.2K rpm SFF (2.5-inch) SC 512e 1yr Warranty Hard Drive	765464-B21
HP 1TB 6G SAS 7.2K rpm SFF (2.5-inch) SC Midline 1yr Warranty Hard Drive	652749-B21
HP 500GB 6G SAS 7.2K rpm SFF (2.5-inch) SC Midline 1yr Warranty Hard Drive	652745-B21
<b>SAS Hot Plug LFF (3.5-inch) Enterprise (ENT) Drives</b>	
HP 600GB 12G SAS 15K rpm LFF (3.5-inch) SC Converter Enterprise 3yr Warranty Hard Drive	765424-B21
HP 450GB 12G SAS 15K rpm LFF (3.5-inch) SC Converter Enterprise 3yr Warranty Hard Drive	737394-B21
HP 300GB 12G SAS 15K rpm LFF (3.5-inch) SC Converter Enterprise 3yr Warranty Hard Drive	737261-B21
<b>SAS Hot Plug LFF (3.5-inch) Midline (MDL) Drives</b>	
HP 8TB 12G SAS 7.2K rpm LFF (3.5-inch) SC 512e Helium 1yr Warranty Hard Drive	793703-B21
HP 6TB 12G SAS 7.2K rpm LFF (3.5-inch) SC 512e Helium 1yr Warranty Hard Drive	793699-B21
HP 6TB 12G SAS 7.2K rpm LFF (3.5-inch) SC Midline 512e 1yr Warranty Hard Drive	765259-B21
HP 6TB 6G SAS 7.2K rpm LFF (3.5-inch) SC Midline 1yr Warranty Hard Drive	761477-B21
HP 6TB 12G SAS 7.2K rpm LFF (3.5-inch) SC 512e Performance 1yr Warranty Hard Drive	793671-B21
HP 4TB 12G SAS 7.2K rpm LFF (3.5-inch) SC Midline 512e 1yr Warranty Hard Drive	765257-B21
HP 4TB 6G SAS 7.2K rpm LFF (3.5-inch) SC Midline 1yr Warranty Hard Drive	695510-B21
HP 4TB 12G SAS 7.2K rpm LFF (3.5-inch) SC 512e Performance 1yr Warranty Hard Drive	793669-B21
HP 3TB 6G SAS 7.2K rpm LFF (3.5-inch) SC Midline 1yr Warranty Hard Drive	652766-B21
HP 2TB 6G SAS 7.2K rpm LFF (3.5-inch) SC Midline 1yr Warranty Hard Drive	652757-B21
HP 1TB 6G SAS 7.2K rpm LFF (3.5-inch) SC Midline 1yr Warranty Hard Drive	652753-B21
<b>SATA Hot Plug SFF (2.5-inch) Midline (MDL) Drives</b>	
HP 2TB 6G SATA 7.2K rpm SFF (2.5-inch) SC 512e 1yr Warranty Hard Drive	765455-B21
HP 1TB 6G SATA 7.2K rpm SFF (2.5-inch) SC 512e 1yr Warranty Hard Drive	765453-B21
HP 1TB 6G SATA 7.2K rpm SFF (2.5-inch) SC Midline 1yr Warranty Hard Drive	655710-B21
HP 500GB 6G SATA 7.2K rpm SFF (2.5-inch) SC Midline 1yr Warranty Hard Drive	655708-B21
<b>SATA Hot Plug LFF (3.5-inch) Midline (MDL) Drives</b>	
HP 8TB 6G SATA 7.2K rpm LFF (3.5-inch) SC 512e Helium 1yr Warranty Hard Drive	793695-B21
HP 6TB 6G SATA 7.2K rpm LFF (3.5-inch) SC 512e Helium 1yr Warranty Hard Drive	793683-B21
HP 6TB 6G SATA 7.2K rpm LFF (3.5-inch) SC Midline 512e 1yr Warranty Hard Drive	765255-B21
HP 6TB 6G SATA 7.2K rpm LFF (3.5-inch) SC Midline 1yr Warranty Hard Drive	753874-B21
HP 6TB 6G SATA 7.2K rpm LFF (3.5-inch) SC 512e Performance 1yr Warranty Hard Drive	793667-B21
HP 4TB 6G SATA 7.2K rpm LFF (3.5-inch) SC Midline 512e 1yr Warranty Hard Drive	765253-B21
HP 4TB 6G SATA 7.2k rpm LFF (3.5-inch) SC Midline 1yr Warranty Hard Drive	693687-B21

## Core Options

HP 4TB 6G SATA 7.2K rpm LFF (3.5-inch) SC 512e Performance 1yr Warranty Hard Drives	793665-B21
HP 3TB 6G SATA 7.2K rpm LFF (3.5-inch) SC Midline 1yr Warranty Hard Drive	628061-B21
HP 2TB 6G SATA 7.2K rpm LFF (3.5-inch) SC Midline 1yr Warranty Hard Drive	658079-B21
HP 1TB 6G SATA 7.2K rpm LFF (3.5-inch) SC Midline 1yr Warranty Hard Drive	657750-B21
HP 500GB 6G SATA 7.2K rpm LFF (3.5-inch) SC Midline 1yr Warranty Hard Drive	658071-B21
<b>SATA Non-Hot Plug LFF (3.5-inch) Midline (MDL) Drives</b>	
HP 4TB 6G SATA 7.2K rpm LFF (3.5in) Non-hot Plug Standard 1yr Warranty Hard Drive	801888-B21
HP 3TB 6G SATA 7.2K rpm LFF (3.5-inch) Non-hot plug Midline 1yr Warranty Hard Drive	628065-B21
HP 3TB 6G SATA 7.2K rpm LFF (3.5in) Non-hot Plug Standard 1yr Warranty Hard Drive	801886-B21
HP 2TB 6G SATA 7.2K rpm LFF (3.5-inch) Non-hot plug Midline 1yr Warranty Hard Drive	659339-B21
HP 2TB 6G SATA 7.2K rpm LFF (3.5in) Non-hot Plug Standard 1yr Warranty Hard Drive	801884-B21
HP 1TB 6G SATA 7.2K rpm LFF (3.5-inch) Non-hot plug Midline 1yr Warranty Hard Drive	659337-B21
HP 1TB 6G SATA 7.2K rpm LFF (3.5in) Non-hot Plug Standard 1yr Warranty Hard Drive	801882-B21
HP 500GB 6G SATA 7.2K rpm LFF (3.5-inch) Non-hot plug Midline 1yr Warranty Hard Drive	659341-B21
<b>12G SAS Hot Plug SFF (2.5-inch) Enterprise Mainstream Solid State Drives</b>	
HP 1.6TB 12G SAS Mainstream Endurance SFF 2.5-in ENT Mainstream SC 3yr Wty H2 Solid State Drive	779176-B21
HP 800GB 12G SAS Mainstream Endurance SFF 2.5-in ENT Mainstream SC 3yr Wty H2 Solid State Drive	779172-B21
HP 400GB 12G SAS Mainstream Endurance SFF 2.5-in ENT Mainstream SC 3yr Wty H2 Solid State Drive	779168-B21
HP 200GB 12G SAS Mainstream Endurance SFF 2.5-in ENT Mainstream SC 3yr Wty H2 Solid State Drive	779164-B21
HP 200GB 12G SAS Write Intensive SFF 2.5-in SC 3yr Wty Solid State Drive	802578-B21
HP 400GB 12G SAS Write Intensive SFF 2.5-in SC 3yr Wty Solid State Drive	802582-B21
HP 800GB 12G SAS Write Intensive SFF 2.5-in SC 3yr Wty Solid State Drive	802586-B21
<b>12G SAS Hot Plug SFF (2.5-inch) Enterprise Value Solid State Drives</b>	
HP 1.6TB 12G SAS Value Endurance SFF 2.5-in SC Enterprise Value 3yr Wty Solid State Drive	762263-B21
HP 800GB 12G SAS Value Endurance SFF 2.5-in SC Enterprise Value 3yr Wty Solid State Drive	762261-B21
HP 1.92TB 12G SAS Read Intensive SFF 2.5-in SC 3yr Wty Solid State Drive	802891-B21
<b>12G SAS Hot Plug LFF (3.5-inch) Enterprise Value Solid State Drives</b>	
HP 1.6TB 12G SAS Value Endurance LFF 3.5-in SC Enterprise Value 3yr Wty Solid State Drive	762272-B21
HP 800GB 12G SAS Value Endurance LFF 3.5-in SC Enterprise Value 3yr Wty Solid State Drive	762270-B21
<b>6G SATA Hot Plug SFF (2.5-inch) Enterprise Mainstream Solid State Drives</b>	
HP 800GB 6G SATA Mainstream Endurance SFF 2.5-in SC Enterprise Mainstream 3yr Wty Solid State Drive	691868-B21

## Core Options

HP 400GB 6G SATA Mainstream Endurance SFF 2.5-in SC Enterprise Mainstream 3yr Wty Solid State Drive	691866-B21
HP 200GB 6G SATA Mainstream Endurance SFF 2.5-in SC Enterprise Mainstream 3yr Wty Solid State Drive	691864-B21
HP 100GB 6G SATA Mainstream Endurance SFF 2.5-in SC Enterprise Mainstream 3yr Wty Solid State Drive	691862-B21
HP 200GB 6G SATA Write Intensive-2 SFF 2.5-in SC 3yr Wty Solid State Drive	804639-B21
HP 400GB 6G SATA Write Intensive-2 SFF 2.5-in SC 3yr Wty Solid State Drive	804665-B21
HP 800GB 6G SATA Write Intensive-2 SFF 2.5-in SC 3yr Wty Solid State Drive	804671-B21
HP 1.2TB 6G SATA Write Intensive-2 SFF 2.5-in SC 3yr Wty Solid State Drive	804677-B21
<b>6G SATA Hot Plug SFF (2.5-inch) Enterprise Value Solid State Drives</b>	
HP 1.6TB 6G SATA Value Endurance SFF 2.5-in SC Enterprise Value 3yr Wty Solid State Drive	757339-B21
HP 800GB 6G SATA Value Endurance SFF 2.5-in SC Enterprise Value 3yr Wty Solid State Drive	717973-B21
HP 600GB 6G SATA Value Endurance SFF 2.5-in SC Enterprise Value 3yr Wty Solid State Drive	739898-B21
HP 480GB 6G SATA Value Endurance SFF 2.5-in SC Enterprise Value 3yr Wty Solid State Drive	717971-B21
HP 300GB 6G SATA Value Endurance SFF 2.5-in SC Enterprise Value 3yr Wty Solid State Drive	739888-B21
HP 240GB 6G SATA Value Endurance SFF 2.5-in SC Enterprise Value 3yr Wty Solid State Drive	717969-B21
HP 240GB 6G SATA Read Intensive SFF 2.5-in SC 3yr Wty Solid State Drive	789135-B21
HP 480GB 6G SATA Read Intensive SFF 2.5-in SC 3yr Wty Solid State Drive	789145-B21
HP 960GB 6G SATA Read Intensive SFF 2.5-in SC 3yr Wty Solid State Drive	789155-B21
HP 80GB 6G SATA Read Intensive-2 SFF 2.5-in SC 3yr Wty Solid State Drive	804575-B21
HP 120GB 6G SATA Read Intensive-2 SFF 2.5-in SC 3yr Wty Solid State Drive	804581-B21
HP 240GB 6G SATA Read Intensive-2 SFF 2.5-in SC 3yr Wty Solid State Drive	804587-B21
HP 480GB 6G SATA Read Intensive-2 SFF 2.5-in SC 3yr Wty Solid State Drive	804593-B21
HP 800GB 6G SATA Read Intensive-2 SFF 2.5-in SC 3yr Wty Solid State Drive	804599-B21
HP 1.6TB 6G SATA Read Intensive-2 SFF 2.5-in SC 3yr Wty Solid State Drive	804605-B21
<b>6G SATA Hot Plug RI-3 SFF (2.5-inch) SC Solid State Drives</b>	
HP 3.84TB 6G SATA Read Intensive-3 SFF 2.5-in SC 3yr Wty Solid State Drive	816929-B21
HP 1.92TB 6G SATA Read Intensive-3 SFF 2.5-in SC 3yr Wty Solid State Drive	816919-B21
HP 960GB 6G SATA Read Intensive-3 SFF 2.5-in SC 3yr Wty Solid State Drive	816909-B21
HP 480GB 6G SATA Read Intensive-3 SFF 2.5-in SC 3yr Wty Solid State Drive	816899-B21
HP 240GB 6G SATA Read Intensive-3 SFF 2.5-in SC 3yr Wty Solid State Drive	816889-B21
HP 120GB 6G SATA Read Intensive-3 SFF 2.5-in SC 3yr Wty Solid State Drive	816879-B21
<b>6G SATA Hot Plug SFF Value Endurance (2.5-inch) Enterprise Value G1 Solid State Drives</b>	
HP 480GB 6G SATA Value Endurance SFF 2.5-in SC Enterprise Value 3yr Wty G1 Solid State Drive	756657-B21
HP 240GB 6G SATA Value Endurance SFF 2.5-in SC Enterprise Value 3yr Wty G1 Solid State Drive	756636-B21
HP 120GB 6G SATA Value Endurance SFF 2.5-in SC Enterprise Value 3yr Wty G1 Solid State Drive	756621-B21
<b>6G SATA Hot Plug SFF (2.5-inch) Enterprise Light G1 Solid State Drives</b>	

## Core Options

HP 960GB 6G SATA Light Endurance SFF 2.5-in SC Enterprise Light 3yr Wty G1 Solid State Drive	756601-B21
HP 200GB 6G SATA Mixed Use-2 SFF 2.5-in SC 3yr Wty Solid State Drive	804613-B21
HP 800GB 6G SATA Mixed Use-2 SFF 2.5-in SC 3yr Wty Solid State Drive	804625-B21
HP 1.6TB 6G SATA Mixed Use-2 SFF 2.5-in SC 3yr Wty Solid State Drive	804631-B21
HP 480GB 6G SATA Mixed Use-2 SFF 2.5-in SC 3yr Wty Solid State Drive	832414-B21
<b>6G SATA Hot Plug MU-3 SFF (2.5-inch) SC Solid State Drives</b>	
HP 1.92TB 6G SATA Mixed Use-3 SFF 2.5-in SC 3yr Wty Solid State Drive	817011-B21
HP 960GB 6G SATA Mixed Use-3 SFF 2.5-in SC 3yr Wty Solid State Drive	816995-B21
HP 480GB 6G SATA Mixed Use-3 SFF 2.5-in SC 3yr Wty Solid State Drive	816985-B21
HP 240GB 6G SATA Mixed Use-3 SFF 2.5-in SC 3yr Wty Solid State Drive	816975-B21
HP 120GB 6G SATA Mixed Use-3 SFF 2.5-in SC 3yr Wty Solid State Drive	816965-B21
<b>6G SATA Hot Plug SFF Value Endurance (2.5-inch) Enterprise Value M1 Solid State Drives</b>	
HP 800GB 6G SATA Value Endurance SFF 2.5-in SC Enterprise Value 3yr Wty M1 Solid State Drive	764929-B21
HP 480GB 6G SATA Value Endurance SFF 2.5-in SC Enterprise Value 3yr Wty M1 Solid State Drive	764927-B21
HP 240GB 6G SATA Value Endurance SFF 2.5-in SC Enterprise Value 3yr Wty M1 Solid State Drive	764925-B21
HP 120GB 6G SATA Value Endurance SFF 2.5-in SC Enterprise Value 3yr Wty M1 Solid State Drive	764923-B21
<b>6G SATA Hot Plug SFF (2.5-inch) Enterprise Boot Solid State Drives</b>	
HP 120GB 6G SATA Value Endurance SFF 2.5-in SC Enterprise Boot 3yr Wty Solid State Drive	717965-B21
HP 80GB 6G SATA Value Endurance SFF 2.5-in SC Enterprise Boot 3yr Wty Solid State Drive	734360-B21
<b>6G SATA Hot Plug LFF (3.5-inch) Enterprise Mainstream Solid State Drives</b>	
HP 800GB 6G SATA Mainstream Endurance LFF 3.5-in SC Enterprise Mainstream 3yr Wty Solid State Drive	691860-B21
HP 400GB 6G SATA Mainstream Endurance LFF 3.5-in SC Enterprise Mainstream 3yr Wty Solid State Drive	691856-B21
HP 200GB 6G SATA Mainstream Endurance LFF 3.5-in SC Enterprise Mainstream 3yr Wty Solid State Drive	691854-B21
HP 100GB 6G SATA Mainstream Endurance LFF 3.5-in SC Enterprise Mainstream 3yr Wty Solid State Drive	691852-B21
HP 200GB 6G SATA Write Intensive-2 LFF 3.5-in SCC 3yr Wty Solid State Drive	804642-B21
HP 400GB 6G SATA Write Intensive-2 LFF 3.5-in SCC 3yr Wty Solid State Drive	804668-B21
HP 800GB 6G SATA Write Intensive-2 LFF 3.5-in SCC 3yr Wty Solid State Drive	804674-B21
HP 1.2TB 6G SATA Write Intensive-2 LFF 3.5-in SCC 3yr Wty Solid State Drive	804680-B21
<b>6G SATA Hot Plug LFF Value Endurance (3.5-inch) Converter Enterprise Value G1 Solid State Drives</b>	
HP 480GB 6G SATA Value Endurance LFF 3.5-in SC Converter ENT Value 3yr Wty G1 Solid State Drive	756660-B21
HP 240GB 6G SATA Value Endurance LFF 3.5-in SC Converter ENT Value 3yr Wty G1 Solid State Drive	756639-B21
HP 120GB 6G SATA Value Endurance LFF 3.5-in SC Converter ENT Value 3yr Wty G1 Solid State Drive	756624-B21

## Core Options

**6G SATA Hot Plug LFF Value Endurance (3.5-inch) Converter Enterprise Value M1****Solid State Drives**

HP 800GB 6G SATA Value Endurance LFF 3.5-in SC Converter ENT Value 3yr Wty M1 Solid State Drive	764945-B21
HP 480GB 6G SATA Value Endurance LFF 3.5-in SC Converter ENT Value 3yr Wty M1 Solid State Drive	764943-B21
HP 240GB 6G SATA Value Endurance LFF 3.5-in SC Converter ENT Value 3yr Wty M1 Solid State Drive	764941-B21
HP 120GB 6G SATA Value Endurance LFF 3.5-in SC Converter ENT Value 3yr Wty M1 Solid State Drive	764939-B21

**6G SATA Hot Plug LFF (3.5-inch) Enterprise Value Solid State Drives**

HP 1.6TB 6G SATA Value Endurance LFF 3.5-in SC Converter Enterprise Value 3yr Wty Solid State Drive	757342-B21
HP 800GB 6G SATA Value Endurance LFF 3.5-in SC Enterprise Value 3yr Wty Solid State Drive	718189-B21
HP 600GB 6G SATA Value Endurance LFF 3.5-in SC Converter Enterprise Value 3yr Wty Solid State Drive	739900-B21
HP 480GB 6G SATA Value Endurance LFF 3.5-in SC Enterprise Value 3yr Wty Solid State Drive	718183-B21
HP 300GB 6G SATA Value Endurance LFF 3.5-in SC Converter Enterprise Value 3yr Wty Solid State Drive	739890-B21
HP 240GB 6G SATA Value Endurance LFF 3.5-in SC Enterprise Value 3yr Wty Solid State Drive	718177-B21
HP 240GB 6G SATA Read Intensive LFF 3.5-in SC Converter 3yr Wty Solid State Drive	789137-B21
HP 480GB 6G SATA Read Intensive LFF 3.5-in SC Converter 3yr Wty Solid State Drive	789147-B21
HP 960GB 6G SATA Read Intensive LFF 3.5-in SC Converter 3yr Wty Solid State Drive	789157-B21
HP 80GB 6G SATA Read Intensive-2 LFF 3.5-in SCC 3yr Wty Solid State Drive	804578-B21
HP 120GB 6G SATA Read Intensive-2 LFF 3.5-in SCC 3yr Wty Solid State Drive	804584-B21
HP 240GB 6G SATA Read Intensive-2 LFF 3.5-in SCC 3yr Wty Solid State Drive	804590-B21
HP 480GB 6G SATA Read Intensive-2 LFF 3.5-in SCC 3yr Wty Solid State Drive	804596-B21
HP 800GB 6G SATA Read Intensive-2 LFF 3.5-in SCC 3yr Wty Solid State Drive	804602-B21
HP 1.6TB 6G SATA Read Intensive-2 LFF 3.5-in SCC 3yr Wty Solid State Drive	804608-B21

**6G SATA Hot Plug LFF (3.5-inch) RI-3 SCC SSD**

HP 3.84TB 6G SATA Read Intensive-3 LFF 3.5-in SC Converter 3yr Wty Solid State Drive	816933-B21
HP 1.92TB 6G SATA Read Intensive-3 LFF 3.5-in SC Converter 3yr Wty Solid State Drive	816923-B21
HP 960GB 6G SATA Read Intensive-3 LFF 3.5-in SC Converter 3yr Wty Solid State Drive	816913-B21
HP 480GB 6G SATA Read Intensive-3 LFF 3.5-in SC Converter 3yr Wty Solid State Drive	816903-B21
HP 240GB 6G SATA Read Intensive-3 LFF 3.5-in SC Converter 3yr Wty Solid State Drive	816893-B21
HP 120GB 6G SATA Read Intensive-3 LFF 3.5-in SC Converter 3yr Wty Solid State Drive	816883-B21

**6G SATA Hot Plug LFF (3.5-inch) Enterprise Light G1 Solid State Drives**



## Core Options

HP 960GB 6G SATA Light Endurance LFF 3.5-in SC Converter ENT Light 3yr Wty G1 Solid State Drive	756604-B21
HP 200GB 6G SATA Mixed Use-2 LFF 3.5-in SCC 3yr Wty Solid State Drive	804616-B21
HP 800GB 6G SATA Mixed Use-2 LFF 3.5-in SCC 3yr Wty Solid State Drive	804628-B21
HP 1.6TB 6G SATA Mixed Use-2 LFF 3.5-in SCC 3yr Wty Solid State Drive	804634-B21
HP 480GB 6G SATA Mixed Use-2 LFF 3.5-in SCC 3yr Wty Solid State Drive	832417-B21
<b>6G SATA Hot Plug LFF (3.5-inch) MU-3 SCC SSD</b>	
HP 1.92TB 6G SATA Mixed Use-3 LFF 3.5-in SC Converter 3yr Wty Solid State Drive	817015-B21
HP 960GB 6G SATA Mixed Use-3 LFF 3.5-in SC Converter 3yr Wty Solid State Drive	816999-B21
HP 480GB 6G SATA Mixed Use-3 LFF 3.5-in SC Converter 3yr Wty Solid State Drive	816989-B21
HP 240GB 6G SATA Mixed Use-3 LFF 3.5-in SC Converter 3yr Wty Solid State Drive	816979-B21
HP 120GB 6G SATA Mixed Use-3 LFF 3.5-in SC Converter 3yr Wty Solid State Drive	816969-B21
<b>6G SATA Hot Plug LFF (3.5-inch) Enterprise Boot Solid State Drives</b>	
HP 120GB 6G SATA Value Endurance LFF 3.5-in SC Enterprise Boot 3yr Wty Solid State Drive	718171-B21
HP 80GB 6G SATA Value Endurance LFF 3.5-in SC Enterprise Boot 3yr Wty Solid State Drive	734362-B21
<b>M.2 SSD</b>	
HP Dual 120GB Value Endurance Solid State M.2 Enablement Kit for ProLiant ML/DL Servers	777894-B21
HP 120GB Value Endurance Solid State M.2 Enablement Kit for ProLiant ML/DL Servers	788028-B21
<b>NOTE: M.2 drives go in PCIe slot and use B140i SATA controller only.</b>	
<b>Hard Drive Blank Kits</b>	
HP Large Form Factor Hard Drive Blank Kit	666986-B21
HP Small Form Factor Hard Drive Blank Kit	666987-B21
<b>Hard Drive Kits</b>	
HP DL180 Gen9 8SFF Hard Drive Cage/Backplane Kit	725572-B21
HP DL180 Gen9 12LFF Hot Plug Enablement Kit	725574-B21

## HP Networking

<b>1 Gigabit Ethernet adapters</b>	
HP Ethernet 1Gb 4-port 331T Adapter	647594-B21
HP Ethernet 1Gb 2-port 332T Adapter	615732-B21
HP Ethernet 1Gb 2-port 361T Adapter	652497-B21
HP Ethernet 1Gb 4-port 366T Adapter	811546-B21
<b>10 Gigabit Ethernet adapters</b>	
HP Ethernet 10Gb 2-port 530SFP Adapter	652503-B21
HP Ethernet 10Gb 2-port 530T Adapter	656596-B21
HP Ethernet 10Gb 2-port 561T Adapter	716591-B21
HP Ethernet 10Gb 2-port 560SFP+ Adapter	665249-B21
HP Ethernet 10Gb 2-port 546SFP+ Adapter	779793-B21
<b>FlexibleLOM Adapters</b>	
HP Ethernet 1Gb 4-port 331FLR Adapter	629135-B22
HP Ethernet 1Gb 4-port 366FLR Adapter	665240-B21
HP Ethernet 10Gb 2-port 561FLR-T Adapter	700699-B21
HP FlexFabric 10Gb 2-port 534FLR-SFP+ Adapter	700751-B21
HP FlexFabric 10Gb 2-port 533FLR-T Adapter	700759-B21

## Core Options

HP Ethernet 10Gb 2-port 546FLR-SFP+ Adapter	779799-B21
HP Ethernet 10Gb 2-port 560FLR-SFP+ Adapter	665243-B21

## HP InfiniBand

HP InfiniBand FDR 2-port 545QSFP Adapter	702211-B21
HP InfiniBand FDR/Ethernet 10Gb/40Gb 2-port 544+FLR-QSFP Adapter	764285-B21
HP InfiniBand FDR/Ethernet 10Gb/40Gb 2-port 544+QSFP Adapter	764284-B21
HP InfiniBand QDR/Ethernet 10Gb 2-port 544+FLR-QSFP Adapter	764286-B21

## HP I/O Expansion Options

HP DL180 Gen9 3 Slot x8 PCI-E Riser Kit	725569-B21
HP DL180 Gen9 x16 PCI-E Riser Kit	725570-B21
HP DL180 Gen9 FlexibleLOM Enablement Kit	780965-B21

## HP Power Supplies

## HP Entry-Level Power Supplies

HP 550W FIO Power Supply Kit	730941-B21
------------------------------	------------

**NOTE:** The above power supply option is 80Plus Silver-certified with an efficiency rating of up to 89%. Power specifications and technical content for all HP Server power supplies can be found at <http://www.hp.com/go/proliant/powersupply>.

HP 800W Gold (Redundant)/900W (Non-Redundant) AC Power Input Module	744689-B21
---------------------------------------------------------------------	------------

**NOTE:** HP Server RPS Backplane Kit (P/N: 745813-B21) is required for this power supply.

**NOTE:** Up to two of these option kits can be selected in one system.

**NOTE:** This kit is only available as option kit and cannot be factory installed in the server.

**NOTE:** With just one power supply module installed, up to 900W wattage is supported while with both power supply modules installed in RPS mode, up to 800W is supported

HP Server Redundant Power Supply Backplane Kit	745813-B21
------------------------------------------------	------------

**NOTE:** This kit is only available as option kit and cannot be factory installed in the server.

**NOTE:** The above power supply option is 80Plus Gold-certified with an efficiency rating of up to 92%. Each power backplane kit (745813-B21) can support up to two (2) AC power input modules (744689-B21). Power specifications and technical content for all HP Server power supplies can be found at <http://www.hp.com/go/proliant/powersupply>.

HP 800W Gold (Redundant)/900W (Non-Redundant) AC Power Input FIO Module	813534-B21
-------------------------------------------------------------------------	------------

**NOTE:** HP Server RPS FIO Backplane Kit (P/N: 813535-B21) is required for this power supply.

**NOTE:** Up to two of these option kits can be installed in one system.

**NOTE:** This FIO kit only be bought integrated in the server. It cannot be ordered as standalone option after server purchase.

**NOTE:** With just one power supply module installed, up to 900W wattage is supported while with both power supply modules installed in RPS mode, up to 800W is supported

HP Server Redundant Power Supply Backplane FIO Kit	813535-B21
----------------------------------------------------	------------

**NOTE:** Required for RPS capability.

**NOTE:** This FIO kit only be bought integrated in the server. It cannot be ordered as standalone option after server purchase.

**NOTE:** The above power supply option is 80Plus Gold-certified with an efficiency rating of up to 92%. Each power backplane kit (813535-B21) can support up to two (2) AC power input modules (813534-B21). Power specifications and

### Core Options

technical content for all HP Server power supplies can be found at <http://www.hp.com/go/proliant/powersupply>.

#### HP Computation and Graphics Accelerators

HP NVIDIA Quadro K2200 Graphics Accelerator	J0G89A
HP NVIDIA Quadro K4200 Graphics Accelerator	J0G90A
<b>NOTE:</b> 1 Graphics Adapter Kit 725576-B21 must be selected per K4200.	
HP DL180 Gen9 Graphic Card Adapter Kit	725576-B21
<b>NOTE:</b> Must select 2 processor if 2 graphic cards are selected.	
<b>NOTE:</b> Must select 800W Gold (redundant)/900W non-redundant power supply when 2 graphic cards are selected.	
<b>NOTE:</b> Only the above listed Graphics cards are HP standard supported options in this server.	
<b>NOTE:</b> The NVIDIA Quadro modules are supported only on 64-bit versions of Linux and Windows operating systems as well as on Virtual Machine client operating systems. The supported bare metal operating systems are RHEL6, SLES 11 and Windows Server 2012 R2.	
<b>NOTE:</b> Please see the HP Power Advisor for estimated power consumption of your individual system configuration prior to installing GPUs. The HP Power Advisor is located at: <a href="http://www.hp.com/go/hppoweradvisor">http://www.hp.com/go/hppoweradvisor</a> .	

#### HP Cooling Options

HP DL180 Gen9 Redundant Fan FIO Kit	779841-B21
<b>NOTE:</b> Upgrades a non-redundant server with one additional hot-plug fan (FIO only).	
HP DL180 Gen9 Redundant Fan Kit	725571-B21
<b>NOTE:</b> Customers can upgrade to a redundant fan configuration with the purchase of above option kit (contains 2 Fans).	



## Additional Options

**NOTE:** Some options may not be integrated at the factory. To ensure only valid configurations are ordered, HP recommends the use of an HP approved configurator. Contact your local sales representative for additional information.

<b>Embedded Management</b>	<b>HP iLO Advanced</b>	
	HP iLO Advanced including 1yr 24x7 Technical Support and Updates Single Server License	512485-B21
	HP iLO Advanced 1 Server License with 3yr 24x7 Tech Support and Updates	BD505A
	HP iLO Advanced including 1yr 24x7 Technical Support and Updates E-LTU	E6U59ABE
	HP iLO Advanced including 3yr 24x7 Technical Support and Updates E-LTU	E6U64ABE
	<b>HP iLO Essentials</b>	
	HP Integrated Lights-Out Essentials including 3yr 24x7 Tech Support and Updates Single Svr License	BD774A
	HP Integrated Lights-Out Essentials including 1yr 24x7 Tech Support and Updates Single Svr License	BD775A
	HP Integrated Lights-Out Essentials including 3yr 24x7 Technical Support and Updates E-LTU	E6U61ABE
	HP Integrated Lights-Out Essentials including 1yr 24x7 Technical Support and Updates E-LTU	E6U62ABE
	<b>HP iLO Scale-out</b>	
	HP Integrated Lights-Out Scale-Out 3yr 24x7 Tech Support and Updates Flex Quantity License	BD776A
	HP Integrated Lights-Out Scale-Out including 3yr 24x7 Tech Support and Updates Flex Qty E-LTU	BD776AAE
	HP Integrated Lights-Out Scale-Out including 3yr 24x7 Tech Support and Updates Tracking License	BD777A
HP Integrated Lights-Out Scale-Out 1yr 24x7 Tech Support and Updates Flex Quantity License	BD778A	
HP Integrated Lights-Out Scale-Out including 1yr 24x7 Tech Support and Updates Flex Qty E-LTU	BD778AAE	
HP Integrated Lights-Out Scale-Out including 1yr 24x7 Tech Support and Updates Tracking License	BD779A	

<b>HP Converged Infrastructure Management Software</b>	<b>HP OneView Advanced (with HP iLO Advanced)</b>	
	HP OneView incl 3yr 24x7 Supp Phys 1 Svr Lic	E5Y34A
	HP OneView incl 3yr 24x7 Supp Flex Qty E-LTU	E5Y35AAE
	HP OneView for ProLiant DL Server incl 3yr 24x7 Supp FIO Bundle Physical 1 Svr Lic	E5Y43A
	<b>HP OneView Advanced (without HP iLO Advanced)</b>	
	HP OneView w/o iLO including 3yr 24x7 Support 1 Server LTU	P8B24A
	HP OneView w/o iLO including 3yr 24x7 Support Flex Quantity E-LTU	P8B26AAE
	HP OneView w/o iLO including 3yr 24x7 Support FIO 1 Server LTU	P8B31A
	HP OneView w/o iLO Adv incl 3yr 24x7 Supp Phys 1 Svr Lic	E5Y38A
	HP OneView w/o iLO Adv inc 3yr 24x7 Supp Flex Qty E-LTU	E5Y39AAE
	HP OneView Media Kit Phys No Lic	E5Y37A
	HP Operations Analytics for HP OneView LTU	K8G29A
HP Operations Analytics for HP OneView E-LTU	K8G29AAE	

**NOTE:** Full licenses of HP OneView Advanced also provide the right-to-use HP Insight Control without additional charge.

**NOTE:** Server provisioning (via 'HP Insight Control server provisioning') is licensed as part of HP OneView Advanced and provides multi-server OS and driver provisioning. Media kit #BD883A can be ordered for a physical copy of this software (USB flash drive).

### Additional Options

**NOTE:** Licenses ship without media. The HP OneView Media Kit can be ordered separately, or can be downloaded at: <http://www.hp.com/go/oneview>.  
**NOTE:** Electronic and Flexible-Quantity licenses can be used to purchase multiple licenses with a single activation key.

#### High Performance Clusters

##### HP Cluster Management Utility

HP Insight Cluster Management Utility 1yr 24x7 Flexible License QL803B  
 HP Insight Cluster Management Utility 3yr 24x7 Flexible License BD476A

**NOTE:** These part numbers can be used to purchase one certificate for multiple licenses and support with a single activation key. Each license is for one node (server). Customer will receive a printed end user license agreement and license entitlement certificate via physical shipment. The license entitlement certificate must be redeemed online in order to obtain a license key. Customer also will receive a support agreement.

HP Insight Cluster Management Utility Media BD477A

**NOTE:** For additional license kits please see the QuickSpecs at: [http://h18004.www1.hp.com/products/quickspecs/12612\\_div/12612\\_div.html](http://h18004.www1.hp.com/products/quickspecs/12612_div/12612_div.html).

#### HP PCIe Workload Accelerator Options

##### Value Endurance (VE) PCIe Workload Accelerators

HP 6.4TB FH/HL Value Endurance (VE) PCIe Workload Accelerator 763840-B21  
 HP 3.2TB HH/HL Value Endurance (VE) PCIe Workload Accelerator 763838-B21  
 HP 1.6TB HH/HL Value Endurance (VE) PCIe Workload Accelerator 763836-B21  
 HP 1.3TB HH/HL Value Endurance (VE) PCIe Workload Accelerator 763834-B21

##### Light Endurance (LE) PCIe Workload Accelerators

HP 5.2TB FH/HL Light Endurance (LE) PCIe Workload Accelerator 775672-B21  
 HP 2.6TB HH/HL Light Endurance (LE) PCIe Workload Accelerator 775670-B21  
 HP 1.3TB HH/HL Light Endurance (LE) PCIe Workload Accelerator 775668-B21  
 HP 1.0TB HH/HL Light Endurance (LE) PCIe Workload Accelerator 775666-B21

**NOTE:** Please see the QuickSpecs for Technical Specifications and additional information: [http://h18000.www1.hp.com/products/quickspecs/14528\\_div/14528\\_div.html](http://h18000.www1.hp.com/products/quickspecs/14528_div/14528_div.html) (Worldwide)

#### HP Security

HP 2U Security Bezel Kit 666988-B21  
**NOTE:** Quick Release Ear option kit (P/N 725579-B21) is required for installing security bezel.

HP DL180 Gen9 Thumbscrew Ear FIO Kit 782641-B21  
**NOTE:** Thumbscrew ears are available on SFF models only.

HP Quick-release Latch Rack Ears FIO Kit 725579-B21  
**NOTE:** Quick-release Latch ears are available on both SFF and LFF models. For 12LFF Models Quick Release Ears are Mandatory.

**NOTE:** Quick-release latch ears upgrades front USB from USB 2.0 to USB 3.0- It also supports Security Bezel Kit.

HP Trusted Platform Module Option 488069-B21

**NOTE:** The TPM (Trusted Platform Module) is a microcontroller chip that can securely store artifacts used to authenticate the server platform. These artifacts can include passwords, certificates and encryption keys. Windows® BitLocker™ Drive Encryption (BitLocker) is a data protection feature available in Windows Server® 2008. BitLocker leverages the enhanced security capabilities of a Trusted Platform Module (TPM) version 1.2. The TPM works with BitLocker to help protect user data and to ensure that a server running Windows Server 2008 has not been tampered with while the system was offline. For more information about TPM, including a white paper, go to: <http://www.hp.com/go/TPM>.

**NOTE:** ProLiant OS pre-installed units will come with the partition required for TPM deployment.

## Additional Options

**NOTE:** The TPM key is unique to every TPM deployed server and must be retained. Misplacing or losing the key could result in data loss.

### HP Storage Controllers

#### SAS Controllers

##### HP Smart Array Controllers

HP Smart Array P440/2GB FBWC 12Gb 1-port Int SAS Controller	820834-B21
HP Smart Array P440/4GB FBWC 12Gb 1-port Int SAS Controller	726821-B21
HP Smart Array P840/4GB FBWC 12Gb 2-ports Int SAS Controller	726897-B21
HP Smart Array P841/4GB FBWC 12Gb 4-ports Ext SAS Controller	726903-B21
HP Smart Array P441/4GB FBWC 12Gb 2-ports Ext SAS Controller	726825-B21
HP Smart Array P440/4GB FBWC 12Gb 1-port Int FIO SAS Controller	761872-B21
<b>NOTE:</b> Includes the HP Smart Storage Battery.	
HP Smart Array P840/4GB FBWC 12Gb 2-ports Int FIO SAS Controller	761874-B21
<b>NOTE:</b> Includes the HP Smart Storage Battery.	

##### HP Smart Host Bus Adapters

HP H240 12Gb 2-ports Int Smart Host Bus Adapter	726907-B21
HP H240 12Gb 2-ports Int FIO Smart Host Bus Adapter	761873-B21
HP H241 12Gb 2-ports Ext Smart Host Bus Adapter	726911-B21

##### HP Cable Options

HP DL180 Gen9 8LFF Smart Array Cable Kit	725577-B21
HP DL180 Gen9 8SFF Smart Array Cable Kit	725578-B21
HP DL180 Gen9 8LFF Hot Plug FIO Cable Kit	774868-B21
HP DL180 Gen9 8LFF Non-hot Plug FIO Cable Kit	774869-B21
HP DL180 Gen9 8SFF Hot Plug FIO Cable Kit	774870-B21
HP DL180 Gen9 4LFF Non-hot Plug FIO Cable Kit	776447-B21

**NOTE:** One of the above cables is required to be selected depending on the combination of chassis and storage controller. Cable option kit descriptions include the right chassis and storage controllers names.

**NOTE:** FIO indicates that this option is only available as a factory installable option. Please select FIO option if you want the option to be factory installed.

**NOTE:** NHP server chassis (Mod-x) includes SATA cables required to connect drives to embedded B140i SATA controller.

##### Optional Upgrades

HP 96W Smart Storage Battery with 145mm Cable for DL/ML/SL Servers	727258-B21
<b>NOTE:</b> This option is mandatorily required with HP Smart Array controllers. One server can accommodate only 1 Smart Storage Battery that would suffice the requirement of all HP Smart Array controllers.	
HP SmartCache No Media 24x7 Technical Support 1 Svr License	D7S26A
HP SmartCache No Media 24x7 Technical Support Flexible License	D7S27A
HP SmartCache No Media 24x7 Technical Support Electronic License	D7S27AAE
HP Secure Encryption No Media Flexible License per Drive	D8S84A
HP Secure Encryption No Media E-LTU per Drive	D8S85AAE

### HP Tape Backup

**NOTE:** For the complete range of tape drives, autoloaders, libraries and media see:

<http://www.hp.com/go/tape>. For hardware and software compatibility of HP tape backup products see: <http://www.hp.com/storage/SPOCK> and <http://www.hp.com/go/ebs>.

**NOTE:** For Internal drives to be connected to DL servers please make sure that you order rack mount kit as well.

#### Tape Libraries

HP MSL2024 0-Drive Tape Library	AK379A
HP MSL4048 0-Drive Tape Library	AK381A

### Additional Options

#### Tape Drives

HP StoreEver LTO-6 Ultrium 6650 SAS External Tape Drive	EH964A
HP StoreEver LTO-6 Ultrium 6250 External Tape Drive	EH970A
HP StoreEver LTO-5 Ultrium 3000 SAS External Tape Drive	EH958B
HP StoreEver LTO-5 Ultrium 3280 SAS External Tape Drive	EH900B
HP StoreEver LTO-4 Ultrium 1760 SAS External Tape Drive	EH920B
HP StoreEver LTO-3 Ultrium 920 SAS External Tape Drive	EH848B

#### HP Tape Storage Systems

HP StoreEver 1U SAS Rack-mount Kit	AE459B
HP StoreEver LTO-4 Ultrium 1760 SAS (1) in 1U Rack-mount Kit	EH946C
HP StoreEver LTO-5 Ultrium 3280 SAS Tape Drive in 3U Rack-mount	EJ013B
HP StoreEver LTO-5 Ultrium 3000 SAS Tape Drive in 1U Rack-mount	EJ014B
HP StoreEver LTO-6 Ultrium 6250 Tape Drive in 1U Rack-mount Kit	COL99A
HP StoreEver 1/8 G2 LTO-6 Ultrium 6250 FC Tape Autoloader	COH19A

#### HP StoreEver MSL6480

HP StoreEver MSL6480 Scalable Base Module	QU625A
HP StoreEver MSL6480 Scaleable Expansion Module	QU626A

#### HP Disk Backup

##### HP RDX Removable Disk Backup System

HP RDX320 USB3.0 External Disk Backup System	B7B63A
HP D3700 Enclosure	QW967A
HP D3600 Enclosure	QW968A
HP RDX+ 500GB External Backup System	B7B66B
HP RDX+ 1TB External Backup System	B7B69B
HP RDX+ External Docking System	C8S07B
HP RDX 2TB USB3.0 External Disk Backup System	E7X53B

#### HP Storage Options

##### Emulex Fibre Channel HBAs

HP 81E 8Gb 1-port PCIe Fibre Channel Host Bus Adapter	AJ762B
HP 82E 8Gb 2-port PCIe Fibre Channel Host Bus Adapter	AJ763B
HP StoreFabric SN1100E 16Gb Single Port Fibre Channel Host Bus Adapter	C8R38A
HP StoreFabric SN1100E 16Gb Dual Port Fibre Channel Host Bus Adapter	C8R39A

##### QLogic Fibre Channel HBAs

HP 82Q 8Gb 2-port PCIe Fibre Channel Host Bus Adapter	AJ764A
HP 81Q 8Gb 1-port PCIe Fibre Channel Host Bus Adapter	AK344A
HP StoreFabric SN1000Q 16GB 1-port PCIe Fibre Channel Host Bus Adapter	QW971A
HP StoreFabric SN1000Q 16GB 2-port PCIe Fibre Channel Host Bus Adapter	QW972A

##### Converged Network Adapter

HP StoreFabric CN1200E 10Gb Converged Network Adapter	E7Y06A
HP StoreFabric CN1100R Dual Port Converged Network Adapter	QW990A

#### HP Disk Storage Systems

##### Disk Enclosures

HP D6000 Dual I/O Module Disk Enclosure	QQ695A
HP D6000 w/35 4TB 6G SAS 7.2K LFF Dual Port MDL HDD 140TB Bundle	E7W30A
HP D6000 w/70 4TB 6G SAS 7.2K LFF Dual Port MDL HDD 280TB Bundle	E7W31A
HP D6000 w/70 3TB 6G SAS 7.2K LFF Dual port MDL HDD 210TB Bundle	QQ700A
HP D6000 w/70 2TB 6G SAS 7.2K LFF Dual port MDL HDD 140TB Bundle	QQ698A
HP D6000 w/35 3TB 6G SAS 7.2K LFF Dual port MDL HDD 105TB Bundle	QQ699A
HP D6000 w/35 2TB 6G SAS 7.2K LFF Dual port MDL HDD 70TB Bundle	QQ697A

## Additional Options

HP D2600 w/12 4TB 6G SAS 7.2K LFF Dual Port MDL HDD 48TB Bundle	E7W32A
HP D6000 w/70 8TB 12G SAS 7.2K LFF (3.5in) Dual Port MDL HDD 560TB Bundle	M0T59A
HP D6000 w/70 6TB 12G SAS 7.2K LFF (3.5in) Dual Port MDL HDD 420TB Bundle	M0T57A
HP D6000 w/35 8TB 12G SAS 7.2K LFF (3.5in) Dual Port MDL HDD 280TB Bundle	M0T58A

## HP Data Center Racks

## HP 11000 G2 Series Racks

HP 11648 1075mm Pallet Universal Rack	H6J87A
HP 11648 1075mm Shock Universal Rack	H6J88A
HP 11642 1075mm Pallet Universal Rack	H6J65A
HP 11642 1075mm Shock Universal Rack	H6J66A
HP 11642 1200mm Pallet Universal Rack	H6J67A
HP 11642 1200mm Shock Universal Rack	H6J68A
HP 11636 1075mm Pallet Universal Rack	H6J77A
HP 11636 1075mm Shock Universal Rack	H6J78A
HP 11622 G2 1075mm Pallet Universal Rack	H6J83A
HP 11622 G2 1075mm Shock Universal Rack	H6J84A
HP 11614 1075mm Shock Universal Rack	H6J82A

**NOTE:** Please see the [HP 11000 G2 Series Racks QuickSpecs](#) for information on additional racks options and rack specifications.

## HP Intelligent Series Rack

HP 647 1075mm Pallet Intelligent Series Rack	BW911A
HP 647 1075mm Shock Intelligent Series Rack	BW912A
HP 647 1200mm Pallet Intelligent Series Rack	BW913A
HP 647 1200mm Shock Intelligent Series Rack	BW914A
HP 642 1075mm Pallet Intelligent Series Rack	BW903A
HP 642 1075mm Shock Intelligent Series Rack	BW904A
HP 642 1200mm Pallet Intelligent Series Rack	BW907A
HP 642 1200mm Shock Intelligent Series Rack	BW908A
HP 636 1075mm Pallet Intelligent Series Rack	BW895A
HP 636 1075mm Shock Intelligent Series Rack	BW896A
HP 842 1075mm Pallet Intelligent Series Rack	BW917A
HP 842 1075mm Shock Intelligent Series Rack	BW918A

**NOTE:** Please see the [HP Intelligent Series Racks QuickSpecs](#) for information on additional racks options and rack specifications.

## HP Value Series Rack

HP V142 1075mm deep Pallet 100 series Rack	AF046A
--------------------------------------------	--------

**NOTE:** Please see the [HP Value Series Rack QuickSpecs](#) for information on additional racks options and rack specifications.

## HP Power Distribution Units (PDUs)

## HP Basic Power Distribution Unit (bPDU)

HP 1.9kVA 120 Volt L5-20 Input (12xNEMA 5-20R) NA/JP Basic PDU	H5M54A
HP 2.8kVA 120 Volt L5-30 Input (18xNEMA 5-20R) NA/JP Basic PDU	H5M55A
HP 3.6kVA 200-240 Volt Detachable C20 Input ( 12xC13) WW Basic PDU	H5M56A
HP 3.6kVA 200-240 Volt Detachable C20 Input (18xC13) WW Basic PDU	H5M57A
HP 4.9kVA 208 Volt L6-30 Input (20xC13) NA/JP Basic PDU	H5M58A
HP 7.3kVA 230 Volt IEC309 32A Input (20xC13) INTL Basic PDU	H5M68A
HP 8.6kVA 208 Volt L15-30 3-Phase Input (18xC13) NA/JP Basic PDU	H5M61A
HP 4.9kVA 208 Volt L6-30 Input (24xC13/6xC19) NA/JP Basic PDU	H5M59A
HP 7.3kVA 230 Volt IEC309 32A Input (24xC13/6xC19) INTL Basic PDU	H5M70A
HP 8.3kVA 208 Volt CS8265C Input (30xC13/6xC19) NA/JP Basic PDU	H5M60A



## Additional Options

HP 11kVA 230 Volt IEC309 63A Input (30xC13/6xC19) INTL Basic PDU	H5M71A
HP Hardwired 200-240 Volt Input (30xC13/6xC19) WW Basic PDU	H5M75A
HP 5.7kVA 208 Volt L21-20 3-Phase Input (24xC13/3xNEMA 5-20R) NA/JP Basic PDU	H5M63A
HP 8.6kVA 208 Volt L21-30 3-Phase Input (24xC13/3xC19/3xNEMA 5-20R) NA/JP Basic PDU	H5M64A
HP 8.6kVA 208 Volt L15-30 3-Phase Input (24xC13/6xC19) NA/JP Basic PDU	H5M62A
HP 11kVA 400 Volt IEC309 16A 3-Phase Input (30xC13/6xC19) INTL Basic PDU	H5M72A
HP 11kVA 400 Volt IEC309 16A 3-Phase Input (36xC13/6xC19) INTL Basic PDU	H5M73A
HP 11kVA 400 Volt IEC309 30A 3-Phase Input (36xC13/6xC19) NA Basic PDU	H5M67A
HP 19.9kVA 480 Volt IEC309 30A 3-Phase Input (30 Outlet) NA Basic PDU	H3X08A
HP 800VA - 277V Input / 230V Output NA Rack Mount Transformer	H3X09A
HP 2.8kVA 24A Low Voltage NA/JP Modular Power Distribution Unit	252663-D71
HP 4.9kVA 24A High Voltage NA/JP Core Modular Power Distribution Unit	252663-D74
HP 8.3kVA 40A High Voltage NA/JP Core Modular Power Distribution Unit	252663-D75
HP 7.3kVA 32A High Voltage INTL Core Modular Power Distribution Unit	252663-B33
HP 9.2kVA 40A High Voltage INTL Core Modular Power Distribution Unit	252663-B34
HP 8.6kVA 24A Three Phase NA/JP Modular Power Distribution Unit	AF512A
HP 11kVA 16A Three Phase INTL Modular Power Distribution Unit	AF513A
HP 14.4kVA 40A Three Phase NA/JP Modular Power Distribution Unit	AF519A
HP 17.3kVA 48A Three Phase NA/JP Modular Power Distribution Unit	AF511A
HP 22kVA 32A Three Phase INTL Core Modular Power Distribution Unit	AF518A

**NOTE:** To learn more about HP Basic Power Distribution Units (bPDU), please visit the HP website at <http://www.hp.com/go/pdu>.

**HP Monitored Power Distribution Units (mPDU)**

HP 2.8kVA 120 Volt L5-30 Input (12xNEMA 5-20R)NA/JP Monitored PDU	D9N43A
HP 3.6kVA 200-240 Volt Detachable C20 Input (12xC13) WW Monitored PDU	D9N46A
HP 4.9kVA 208 Volt L6-30 Input (12xC13) NA/JP Monitored PDU	D9N44A
HP 3.6kVA 200-240 Volt Detachable C20 Input (16xC13) WW Monitored PDU	D9N45A
HP 4.9kVA 208 Volt L6-30 Input (12xC13) NA/JP Monitored PDU	G9Z05A
HP 7.3kVA 230 Volt IEC309 32A Input (12xC13) INTL Monitored PDU	G9Z06A
HP 4.9kVA 208 Volt L6-30 Input (20xC13/4xC19) NA/JP Monitored PDU	D9N47A
HP 7.3kVA 230 Volt IEC309 32A Input (20xC13/4xC19) INTL Monitored PDU	D9N48A
HP 8.6kVA 208 Volt L15-30 3-Phase Input (18xC13/3xC19) NA/JP Monitored PDU	D9N51A
HP 5.7kVA 208 Volt L21-20 3-Phase Input (18xC13/3xNEMA 5-20R) NA/JP Monitored PDU	D9N52A
HP 8.6kVA 208 Volt L21-30 3-Phase Input (20xC13/3xC19/3xNEMA 5-20R) NA/JP Monitored PDU	D9N53A
HP 11kVA 400 Volt IEC309 16A 3-Phase Input (18xC13/3xC19) INTL Monitored PDU	D9N55A
HP 8.3kVA 208 Volt CS8265C Input (30xC13/3xC19) NA Monitored PDU	D9N49A
HP 7.3kVA 230 Volt IEC309 32A Input (32xC13/4xC19) INTL Monitored PDU	D9N50A
HP 11kVA 400 Volt IEC309 16A 3-Phase Input (30xC13/3xC19) INTL Monitored PDU	D9N57A
HP 14.4kVA 208 Volt CS8365C 3-Phase Input (12xC13/12xC19)NA Monitored PDU	D9N58A
HP 16.6kVA 400 Volt IEC309 30A 3-Phase Input (30xC13/3xC19) NA Monitored PDU	D9N61A
HP 16.6kVA 400 Volt IEC309 30A 3-Phase Input (12xC13/12xC19) NA Monitored PDU	D9N62A
HP 17.3kVA 208 Volt IEC309 60A 3-Phase Input (24xC13/3xC19) NA/JP Monitored PDU	D9N54A

## Additional Options

HP 17.3kVA 208 Volt IEC309 60A 3-Phase Input (12xC13/12xC19) NA/JP Monitored PDU	D9N59A
HP 17.3kVA 208 Volt IEC309 60A 3-Phase Watertight Input (12xC13/12xC19) NA/JP Monitored PDU	G9Z07A
HP 19.9kVA 480 Volt 3-Phase (30 Outlet) NA Monitored PDU	D9N63A
HP 22kVA 400 Volt IEC309 32A 3-Phase Input (30xC13/3xC19) INTL Monitored PDU	D9N56A
HP 22kVA 400 Volt IEC309 32A 3-Phase Input (12xC13/12xC19) INTL Monitored PDU	D9N60A
HP 22kVA 400 Volt IEC309 32A 3-Phase Watertight Input (12xC13/12xC19) INTL Monitored PDU	G9Z08A
HP Environmental Sensor for Remote Monitored and Managed PDUs	E2D53A
<b>NOTE:</b> Please see the <a href="#">HP Monitored Power Distribution Units QuickSpecs</a> for information on additional options and product specifications.	
<b>HP Intelligent Power Distribution Units (iPDU)</b>	
HP 4.9kVA 24A Single Phase NA/JP Core Intelligent Modular Power Distribution Unit	AF520A
HP 8.3kVA 40A Single Phase NA/JP Core Intelligent Modular Power Distribution Unit	AF521A
HP 8.6kVA 24A Three Phase NA/JP Core Intelligent Modular Power Distribution Unit	AF522A
HP 17.3kVA 48A Three Phase NA/JP Core Intelligent Modular Power Distribution Unit	AF523A
HP 11.4kVA 16A 415V Three Phase L22-20 NA Core Intelligent Power Distribution Unit	AF900A
HP 17.3kVA 24A 415V Three Phase IEC309 NA Core Intelligent Power Distribution Unit	AF901A
HP 7.3kVA 32A Single Phase INTL Core Intelligent Modular Power Distribution Unit	AF525A
HP 11kVA 16A Three Phase INTL Core Intelligent Modular Power Distribution Unit	AF526A
HP 22kVA 32A Three Phase INTL Core Intelligent Modular Power Distribution Unit	AF527A
HP 17.3kVA 48A 208V Three Phase 12 Outlet Core NA/JP Intelligent Power Distribution Unit	AF535A
HP 17.3kVA 24A 415V Three Phase 12 Outlet Core NA/JP Intelligent Power Distribution Unit	AF537A
HP 22kVA 32A 400V Three Phase 12 Outlet Core INTL Intelligent Power Distribution Unit	AF538A
HP 4.9kVA 24A Single Phase NA/JP Intelligent Modular Power Distribution Kit	AF531A
HP 8.6kVA 24A Three Phase NA/JP Intelligent Modular Power Distribution Kit	AF532A
HP 14.4kVA 40A Three Phase NA/JP Intelligent Modular Power Distribution Unit	AF533A
HP 7.3kVA 32A Single Phase INTL Intelligent Modular Power Distribution Kit	AF534A
HP 5xC13 Intelligent PDU Extension Bar G2 Kit	AF547A
HP 5xC13 Outlets Power and UID LEDs Pair Standard Extension Bar	AF528A
<b>NOTE:</b> Please see the <a href="#">HP Intelligent Power Distribution Units QuickSpecs</a> for information on additional options and product specifications.	
<b>HP Managed Power Distribution Units (maPDU)</b>	
HP 2.8kVA 120 Volt L5-30 Input (24x NEMA 5-20) NA/JP Managed PDU	H8B48A
HP 3.6kVA 200-240 Volt Detachable C20 Input (7xC13/1xC19) WW Managed PDU	H8B49A
HP 4.9kVA 208 Volt L6-30 Input (20xC13/4xC19) NA/JP Managed PDU	H8B50A
HP 7.3kVA 200-240 Volt IEC309 32A Input (20xC13/4xC19) INTL Managed PDU	H8B51A
HP 8.6kVA 208 Volt L15-30 3 Phase Input (18xC13/6xC19) NA/JP Managed PDU	H8B52A
HP 8.6kVA 208 Volt L21-30 3 Phase Input (20xC13/3xC19/1x NEMA 5-20) NA/JP Managed PDU	H8B53A

## Additional Options

HP 11kVA 400 Volt IEC309 16A 3 Phase Input (21xC13/3xC19) INTL Managed PDU	H8B54A
HP 14.4kVA 208V CS8365C 3 Phase Input (12xC13/12xC19) NA/JP Managed PDU	H8B55A
HP 17.3kVA 208V IEC309 60A 3 Phase Input (12xC13/12xC19) NA/JP Managed PDU	H8B56A

**NOTE:** Please see the [HP Managed Power Distribution Units \(maPDU\)](#) for information on additional options and product specifications.

**NOTE:** To learn more, please visit the [HP Uninterruptible Power Systems \(UPS\) web page](#).

### HP Rack Mount Consoles, KVM Switches, and Keyboards

#### HP Location Discovery Services

HP Location Discovery Services LCD8500 Kit	TL052A
--------------------------------------------	--------

**NOTE:** Please see the [HP Location Discovery Services QuickSpecs](#) for information on additional options and product specifications.

#### HP Rack Mount Consoles

HP LCD8500 1U US Rackmount Console Kit	AF630A
HP LCD8500 1U UK Rackmount Console Kit	AF631A
HP LCD8500 1U DE Rackmount Console Kit	AF632A
HP LCD8500 1U FR Rackmount Console Kit	AF633A
HP LCD8500 1U JP Rackmount Console Kit	AF642A
HP LCD8500 1U RU Rackmount Console Kit	AF643A
HP LCD8500 1U INTL Rackmount Console Kit	AF644A
HP LCD8500 1U US TAA Rackmount Console Kit	AF645A

#### HP KVM Switches

HP 0x2x16 G3 KVM Console Switch	AF652A
HP TAA 0x2x16 G3 KVM Console Switch	AF653A
HP USB Remote Access Key for G3 KVM Console Switches	AF650A
HP KVM Console USB Interface Adapter	AF628A
HP 0x2x16 KVM Server Console Switch G2 with Virtual Media CAC Software	AF618A
HP 0x2x32 KVM Server Console Switch G2 with Virtual Media CAC Software	AF619A
HP KVM Console USB 2.0 Virtual Media CAC Interface Adapter	AF629A
HP 1x4 USB/PS2 KVM Console Switch	AF611A
HP 1x1Ex8 KVM IP Console Switch G2 with Virtual Media CAC Software	AF620A
HP 2x1Ex16 KVM IP Console Switch G2 with Virtual Media CAC Software	AF621A
HP 4x1Ex32 KVM IP Console Switch G2 with Virtual Media CAC Software	AF622A

**NOTE:** To learn more, please visit the [HP KVM Switches web page](#).

#### HP USB Keyboard and Mouse

HP USB BFR with PVC Free US Keyboard/Mouse Kit	631341-B21
HP USB BFR with PVC Free Intl Keyboard/Mouse Kit	672097-B33
HP 1U INT Rackmount Keyboard with USB	AG086A
HP 1U US Rackmount Keyboard with USB	AG072A

**NOTE:** Please see the [HP USB Keyboard and Mouse QuickSpecs](#) for information on additional options and product specifications.

#### Rail Kits

HP 2U Small Form Factor Easy Install Rail Kit	733660-B21
<b>NOTE:</b> This applies for both LFF & SFF models and it does not include cable management arm.	
HP 2U Cable Management Arm for Easy Install Rail Kit	733664-B21

#### HP Other Options

HP Rack LED Light Kit	BW939A
HP Kit LCD 1.83m Latch Display Port Cable	G7T29A

## Additional Options

**HP Uninterruptible Power Systems (UPS)****HP DirectFlow Three Phase UPS****Power Unit (1U UPS)**

HP R12000 DirectFlow - 1U Rackmount Uninterruptible Power System G9Y75A

HP R12000 DirectFlow - POD 1U Rackmount Uninterruptible Power System AF478A

**Input/Output Module Options for 1U UPS**

HP 32A 400-415 Volt Three Phase INTL R12000 DirectFlow UPS IEC309 Input/Output Module AF488A

HP 30A 400-415 Volt Three Phase NA R10000 DirectFlow UPS IEC309 Input/Output Module AF489A

HP 32A 380 Volt Three Phase China R12000 DirectFlow UPS Unterminated Input/Output Module AF490A

HP 30A 480 Volt Three Phase NA R12000 DirectFlow UPS L22-30 Input/Output Module AF491A

HP 30A 480 Volt Three Phase NA R12000 DirectFlow UPS IEC309 Input/Output Module AF492A

HP 30A 400-415 Volt Three Phase NA R12000 DirectFlow UPS IEC309 Input/Output Module G9Y76A

**Power Unit (2U UPS)**

HP R18000 DirectFlow - 2U Rackmount Uninterruptible Power System AF479A

**Input/Output Module Options for 2U UPS**

HP 32A 400-415 Volt Three Phase INTL R18000 DirectFlow UPS IEC309 Input/Output Module AF483A

HP 30A 380 Volt Three Phase China R18000 DirectFlow UPS Unterminated Input/Output Module AF485A

HP 30A 480 Volt Three Phase NA R18000 DirectFlow UPS IEC309 Input/Output Module AF486A

HP 30A 480 Volt Three Phase NA R18000 DirectFlow UPS IEC309 Input/Output Module AF487A

HP 30A 400 Volt Three Phase NA R18000 DirectFlow UPS IEC309 Input/Output Module D9Q02A

HP 30A 400-415V Three Phase NA R18000 DirectFlow UPS 1:1 IEC309 Input/Output Module AF484A

**NOTE:** All Input/Output Modules support dual output outlets except the AF484A.**Battery Pack Options**

HP DirectFlow UPS - 1U Rackmount Lithium-ion Battery Pack AF480A

HP DirectFlow UPS - 3U Rackmount VRLA Battery Pack AF482A

HP WW DirectFlow Secondary Battery Cable AF497A

**NOTE:** Please see the [HP DirectFlow Three Phase Uninterruptible Power System QuickSpecs](#) for information on additional options and product specifications.**HP Tower UPS****HP T750 G4 UPS Models**

HP T750 G4 NA/JP Uninterruptible Power System J2P85A

HP T750 G4 INTL Uninterruptible Power System J2P88A

**HP T1000 G4 UPS Models**

HP T1000 G4 NA/JP Uninterruptible Power System J2P86A

HP T1000 G4 INTL Uninterruptible Power System J2P89A

**HP T1500 G4 UPS Models**

HP T1500 G4 NA/JP Uninterruptible Power System J2P87A

HP T1500 G4 INTL Uninterruptible Power System J2P90A

**HP Rack/Tower UPS****HP R/T2200 G4 UPS Models**

HP R/T2200 G4 NA/JP Uninterruptible Power System J2R00A

## Additional Options

**HP R/T3000 G4 UPS Models**

HP R/T3000 G4 Low Voltage NA/JP Uninterruptible Power System	J2R01A
HP R/T3000 G4 High Voltage NA/JP Uninterruptible Power System	J2R02A
HP R/T3000 G4 High Voltage INTL Uninterruptible Power System	J2R04A

**R1500 G4 Models**

HP R1500 G4 NA Uninterruptible Power System	J2Q99A
HP R1500 G4 JP/TWN Uninterruptible Power System	J2R05A
HP R1500 G4 INTL Uninterruptible Power System	J2R03A

**R7000 Uninterruptible Power System (UPS)**

HP R7000 4U 50A High Voltage NA/JP Uninterruptible Power System	AF462A
HP R7000 4U IEC-32A High Voltage INTL Uninterruptible Power System	AF463A

**R5000 Uninterruptible Power System (UPS)**

HP R5000 3U L630 High Voltage NA/JP Uninterruptible Power System	AF460A
HP R5000 3U IEC309-32A High Voltage INTL Uninterruptible Power System	AF461A

**HP UPS Options**

HP R/T2200 G4 Extended Runtime Module	J2R09A
HP R/T3000 G4 Extended Runtime Module	J2R10A
HP 2U Rack/Tower UPS Shipping Kit	L4Q11A

**NOTE:** To learn more, please visit the [HP Uninterruptible Power Systems \(UPS\) web page](#).

**HP USB and SD Options****HP Flash Media Kits for USB Drives**

HP 32GB microSD Enterprise Mainstream Flash Media Kit	700139-B21
HP 8GB microSD Enterprise Mainstream Flash Media Kit	726116-B21
HP Dual 8GB microSD Enterprise Midline USB Kit	741279-B21

**HP Care Pack Services****Foundation Care**

HP 3 year 24x7 DL180 Gen9 Foundation Care Service	U7AT3E
HP 3 year 24x7 with Defective Media Retention DL180 Gen9 Foundation Care Service	U7AT4E
HP 3 year 24x7 with Comprehensive Defective Material Retention DL180 Gen9 Foundation Care Service	U7AT5E

**Proactive Care**

HP 3 year 24x7 DL180 Gen9 Proactive Care Service	U7AT6E
HP 3 year 24x7 with Defective Media Retention DL180 Gen9 Proactive Care Service	U7AT7E
HP 3 year 24x7 with Comprehensive Defective Material Retention DL180 Gen9 Proactive Care Service	U7AT8E

**Installation & Start-up Services**

HP Installation ProLiant DL180/DL380e Service	U6E81E
HP Startup ProLiant DL180/DL380e Service	U6E83E

# QuickSpecs

## HP ProLiant DL180 Generation9 (Gen9)

### Memory

**Memory Subsystem Architecture** Each Intel® Xeon® E5-2600v3 family processor socket contains four memory channels per installed processor with two DIMMs per channel for a total of eight (8) DIMMs or a grand total of sixteen (16) DIMMs for the server.

#### Memory Population guidelines

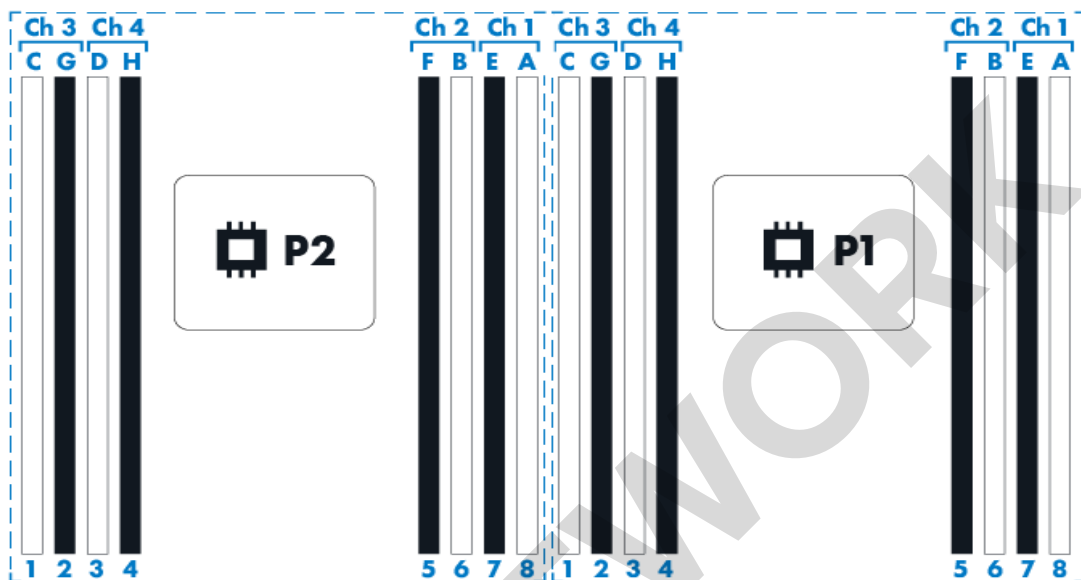

#### General Memory Population Rules and Guidelines:

- Install DIMMs only if the corresponding processor is installed.
- If only one processor is installed in a two processor system, only half of the DIMM slots are available.
- To maximize performance, it is recommended to balance the total memory capacity between all installed processors and load the channels similarly whenever possible.
- When two processors are installed, balance the DIMMs across the two processors.
- White DIMM slots denote the first slot to be populated in a channel.
- Place the DIMMs with the highest number of ranks in the white slot when mixing DIMMs of different ranks on the same channel.
- Do not mix RDIMMs or LRDIMMs.
- Quad rank RDIMMs are not supported in HP ProLiant DL180 Gen9 servers.
- Quad rank LRDIMMs are capable of up to two DIMMs per channel.
- DIMMs of different speeds may be mixed in any order; the server will select a common optimal speed.
- The maximum memory speed is a function of the memory type, memory configuration, and processor model.
- The maximum memory capacity is a function of the memory type and number of installed processors.
- To realize the performance memory capabilities listed in this document, HP SmartMemory is required.

#### Intel Gen9 Supported Memory Bandwidth for HP ProLiant Gen9 Intel® Xeon® E5-2600v3 Series Processor Family

##### Memory Bandwidth and Capacity

[DIMM Type]	Registered DIMMs (RDIMMs)				Load Reduced (LRDIMMs)	
DIMM Rank	Single Rank	Dual Rank			Quad Rank	
DIMM Capacity	4GB	8GB	16GB	32GB	16GB	32GB

# QuickSpecs

## HP ProLiant DL180 Generation9 (Gen9)

### Memory

<b>DIMM Native Speed (MT/s)</b>	2133					
<b>Voltage</b>	Std Voltage 1.2V					
<b>SLOTS THAT CAN BE POPULATED</b>						
16 slot servers	16					
<b>MAXIMUM CAPACITY (GB)</b>						
	64	128	256	512	256	512
<b>1 DIMM Per Channel</b>						
	2133					
<b>2 DIMM Per Channel</b>						
	2133					
<b>3 DIMM Per Channel</b>						
	1600			1866		

### DIMM slot and configuration diagram

#### DIMM slot and configuration diagrams Basic memory slot & population diagram

- Population order; start with "A" first, "B" second, "C" third, etc.
- When one processor is installed, install DIMMs in sequential alphabetic order: A, B, C, D, E, F ...
- When two processors are installed, install DIMMs in sequential alphabetic order: CPU1-A, CPU2-A, CPU1-B, CPU2-B, CPU1-C, CP2-C

CPU #1 IS PROCESSOR ON RIGHT - LOOKING FROM FRONT OF SERVER

	CPU 1			CPU 2		
	Slot #	population order		Slot #	population order	
Chnl 3	1	C		1	C	
	2	G		2	G	
Chnl 4	3	D		3	D	
	4	H		4	H	
Chnl 2	5	F		5	F	
	6	B		6	B	
Chnl 1	7	E		7	E	
	8	A		8	A	

# QuickSpecs

## HP ProLiant DL180 Generation9 (Gen9)

### Memory

Memory Speed by Processor Model	Processor Models	Supported Memory Speeds
	E5-2609v3, E5-2603v3,	1600MHz
	E5-2640v3, E5-2630v3, E5-2630Lv3, E5-2620v3, E5-2623v3,	1866MHz
	E5-2660v3, E5-2650v3, E5-2650Lv3,	2133MHz

Standard and Maximum Memory Capacity (Pre-configured Models)	Pre-Configured Models	Standard Memory	Maximum Memory Plus Optional Memory	Standard Memory Replaced with Optional Memory
	E5-2603v3, E5-2609v3,	8GB (1x8GB)	488GB (15x32GB, 1x8GB)	512GB (16x32GB)
	E5-2623v3,	16GB (2x8GB)	464GB (14x32GB, 2x8GB)	512GB (16x32GB)
	E5-2630v3,	32GB (2x16GB)	480GB (14x32GB, 2x16GB)	512GB (16x32GB)

### DDR4 memory options part number decoder

**NOTE:** Capacity references are rounded to the common gigabyte (GB) values.

- 2GB = 2,048MB
- 4GB = 4,096MB
- 8GB = 8,192MB
- 16GB = 16,384MB
- 32GB = 32,768MB
- 64GB = 65,536MB

### HP gggggg eRxff DDR4 wwwwm a bb-ccd Kit

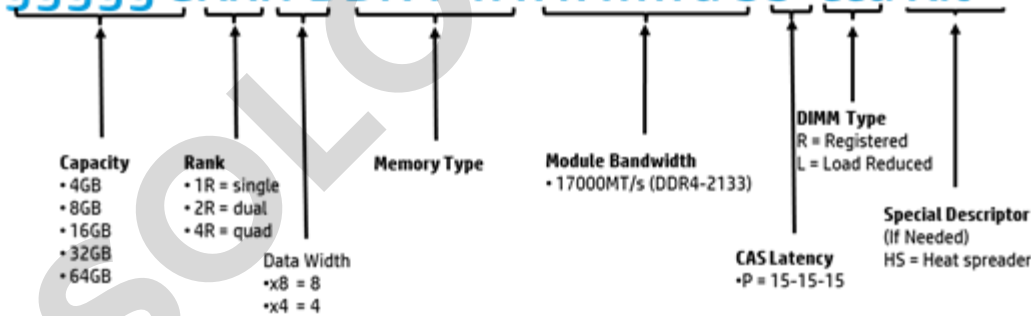



# QuickSpecs

## HP ProLiant DL180 Generation9 (Gen9)

### Storage

4-bay LFF non-hot-plug drive model

1-4

4 x LFF SATA Non-Hot Pluggable Hard Drive Bays

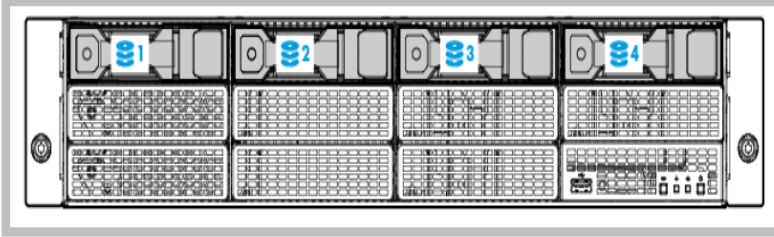

8-bay LFF hot-plug drive model

1-8

8 x LFF SATA/SAS/SDD Hot Pluggable Hard Drive Bays



12-bay LFF hot-plug drive model

1-12

12 x LFF SATA/SAS/SDD Hot Pluggable Hard Drive Bays

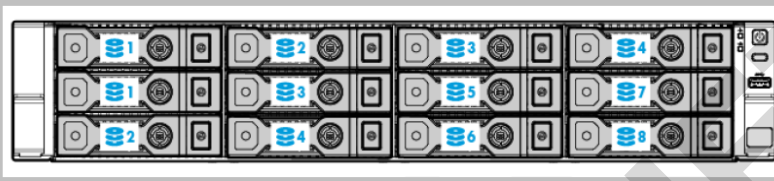

8-bay SFF hot-plug drive model

1-8

8 x SFF SATA/SAS/SDD Hot Pluggable Hard drive bays

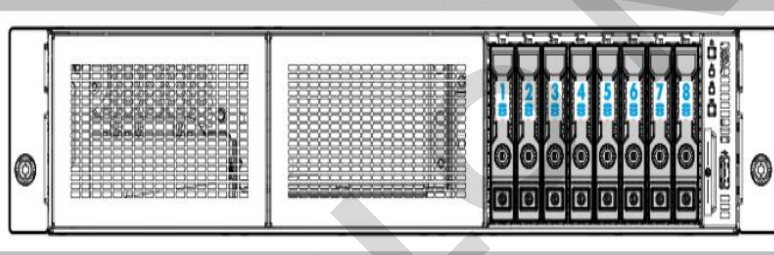

16-bay SFF hot-plug drive model

1-16

16 x SFF SATA/SAS/SDD Hot Pluggable Hard drive bays



### Technical Specifications

<b>System Unit</b>	<b>Dimensions</b> (with bezel)	SFF Drives: 3.44 x 17.54 x 23.9 in (8.75 x 44.55 x 60.7cm) LFF Drives: 3.44 x 17.54 x 23.9 in (8.75 x 44.55 x 60.7 cm)
	<b>Weight</b> (approximate)	Maximum: 47/6 lb (21.59 kg) (all hard drives: front + rear, full power supply, and processor installed) Minimum: 36.58 lb (16.59 kg) (one SFF hard drive, single power supply, and processor installed. HDD not installed)
<b>Input Requirements</b>	Rated Line Voltage	100 to 240 VAC
	Rated Input Current	For 550W Power Supply: 6.7 A (at 100 VAC) 3.3 A (at 200 VAC)
	Rated Input Frequency	47 to 63 Hz
	Rated Input Power	For 550 W Power Supply: < 670 W (at 100 VAC), < 660 W (at 200 VAC),
<b>BTU Rating</b>	Maximum	For 550 W Power Supply: 2201 BTU/hr (at 100 VAC), 2153 BTU/hr (at 200 VAC)
<b>Power Specifications</b>		To review typical system power ratings use the Power Advisor which is available via the online tool located at URL: <a href="http://www.hp.com/go/proliant-energy-efficient">http://www.hp.com/go/proliant-energy-efficient</a> or <a href="http://www.hp.com/go/hppoweradvisor">http://www.hp.com/go/hppoweradvisor</a> - Click on the system of interest. Example: DL180 Gen9- Follow the instructions of the next screens.
<b>Power Supply Output</b>	Rated Steady-State Power	For 550 W Power Supply: 550 W (at 100 VAC), 550 W (at 200 VAC),
	Maximum Peak Power	For 550 W Power Supply: 550 W (at 100 VAC), 550 W (at 200 VAC),
<b>System Inlet Temperature</b>	Standard Operating Support	10° to 35°C (50° to 95°F) at sea level with an altitude derating of 1.0°C per every 305 m (1.8°F per every 1000 ft) above sea level to a maximum of 3050 m (10,000 ft), no direct sustained sunlight. Maximum rate of change is 20°C/hr (36°F/hr). The upper limit and rate of change may be limited by the type and number of options installed. System performance during standard operating support may be reduced if operating with a fan fault or above 30°C (86°F).
	Extended Ambient Operating Support	For approved hardware configurations, the supported system inlet range is extended to be: 5° to 10°C (41° to 50°F) and 35° to 40°C (95° to 104°F) at sea level with an altitude derating of 1.0°C per every 175 m (1.8°F per every 574 ft) above 900 m (2953 ft) to a maximum of 3050 m (10,000 ft). The approved hardware configurations for this system are listed at the URL:

### Technical Specifications

<http://www.hp.com/servers/ashrae>

For approved hardware configurations, the supported system inlet range is extended to be: 40° to 45°C (104° to 113°F) at sea level with an altitude derating of 1.0°C per every 125 m (1.8°F per every 410 ft) above 900 m (2953 ft) to a maximum of 3050 m (10,000 ft). The approved hardware configurations for this system are listed at the URL:

<http://www.hp.com/servers/ashrae>

System performance may be reduced if operating in the extended ambient operating range or with a fan fault.

**NOTE:** Supports A3 and A4 extended ambience.

<b>Relative Humidity</b>	Non-operating	-30° to 60°C (-22° to 140°F). Maximum rate of change is 20°C/hr (36°F/hr).
	Operating	Minimum to be the higher (more moisture) of -12°C (10.4°F) dew point or 8% relative humidity. Maximum to be the lower (less moisture) of 24°C (75.2°F) dew point or 90% relative humidity.
<b>Altitude</b>	(non-condensing) Non-operating	5% to 95% relative humidity (Rh), 38.7°C (101.7°F) maximum wet bulb temperature, non-condensing.
	Operating	3048 m (10,000 ft). This value may be limited by the type and number of options installed. Maximum allowable altitude change rate is 457 m/min (1500 ft/min).
<b>Acoustic Noise</b>	Non-operating	9144 m (30,000 ft). Maximum allowable altitude change rate is 457 m/min (1500 ft/min).
	Listed are the declared A-Weighted sound power levels (LWAd) and declared average bystander position A-Weighted sound pressure levels (LpAm) when the product is operating in a 23°C ambient environment. Noise emissions were measured in accordance with ISO 7779 (ECMA 74) and declared in accordance with ISO 9296 (ECMA 109).	
<b>Idle</b>		
	L WAd	Entry: 5.4 B Base: 5.5 B Storage: 6.3 B Energy Star: 5.5 B
	L pAm	Entry: 39 dBA Base: 39 dBA Storage: 46 dBA Energy Star: 38 dBA
<b>Operating</b>		
	L WAd	Entry: 5.5 B Base: 5.6 B Storage: 6.3 B Energy Star: 5.5 B
	L pAm	Entry: 40 dBA Base: 40 dBA Storage: 46 dBA Energy Star: 38 dBA

**NOTE:** The listed sound levels apply to standard shipping configurations. Additional options may result in increased sound levels.

### Technical Specifications

<b>Emissions Classification (EMC)</b>	FCC Rating Normative Standards	Class A CISPR 22; EN55022; EN55024; FCC CFR 47, Pt 15; ICES-003; CNS14336-1; CNS13438; GB4943; GB9254; EN 61000-3-2; EN 61000-3-3; EN 60950-1; IEC 60950-1
---------------------------------------	-----------------------------------	---------------------------------------------------------------------------------------------------------------------------------------------------------------

**NOTE:** Product conformance to cited product specifications is based on sample (type) testing, evaluation, or assessment. This product or family of products is eligible to bear the appropriate compliance logos and statements.

**NOTE:** The listed sound levels apply to standard shipping configurations. Additional options may result in increased sound levels.

<b>HP Dynamic Smart Array B140i Controller</b>	<b>Number of PCI links</b>	Four
	<b>PCI link rate</b>	4 Gb/s
	<b>Storage protocol support</b>	SATA
	<b>SAS/SATA peak data transfer rate</b>	6 Gb/s
	<b>Number of SAS/SATA links</b>	10 links
	<b>SAS/SATA connectivity</b>	2x4 connectors; 2x1 connectors
	<b>Expander support</b>	No
	<b>Drives supported (max)</b>	Up to 10 Internal Drives
	<b>RAID support</b>	0, 1, 10, 5 SATA
	<b>Software management</b>	HP SSA, SMH, SIM
	<b>Warranty</b>	Server warranty
	<b>HP Secure Encryption license</b>	Not Supported
	<b>HP SmartCache License</b>	Not Supported
<b>HP Smart Storage Administrator</b>	Supported	

<b>HP Embedded Dual Port 361i Adapter</b>	<b>Network Interface</b>	10Base-T/100Base-TX/1000Base-TX		
	<b>Compatibility</b>	IEEE 802.3 10Base-T		
		IEEE 802.3ab 1000Base-T		
		IEEE 802.3u 100Base-TX		
		IEEE 1588, IEEE 802.1AS		
		IEEE 802.3az - Energy Efficient Ethernet (EEE)		
	<b>Data Transfer Method</b>	PCI Express v 2.0, 5.0 GT/s, two lanes (x2)		
	<b>Controller</b>	Intel I350 Powerville		
	<b>Network Transfer Rate</b>	10Base-T (Half-Duplex)	10 Mb/s per port, 40 Mb/s combined	
		10Base-T (Full-Duplex)	20 Mb/s per port, 80 Mb/s combined	

### Technical Specifications

	100Base-TX (Half-Duplex)	100 Mb/s per port, 400 Mb/s combined
	100Base-TX (Full-Duplex)	200 Mb/s per port, 800 Mb/s combined
	1000Base-TX (Half and Full-Duplex)	1000Mb/s per port, 4000 Mb/s combined
<b>Connector</b>	Two RJ-45	
<b>Cable Support</b>	10 Base-T	Categories 3, 4 or 5 UTP; up to 328 ft (100 m)
	10/100/1000 Base-TX	Category 5 or higher UTP; up to 328 ft (100 m)

### Environment-friendly Products and Approach

### End-of-life Management and Recycling

Hewlett-Packard offers end-of-life HP product return, trade-in, and recycling programs in many geographic areas. For trade-in information, please go to: <http://www.hp.com/go/green>. To recycle your product, please go to: <http://www.hp.com/go/green> or contact your nearest HP sales office. Products returned to HP will be recycled, recovered or disposed of in a responsible manner.

The EU WEEE directive (2002/95/EC) requires manufacturers to provide treatment information for each product type for use by treatment facilities. This information (product disassembly instructions) is posted on the Hewlett Packard web site at: <http://www.hp.com/go/green>. These instructions may be used by recyclers and other WEEE treatment facilities as well as HP OEM customers who integrate and re-sell HP equipment.

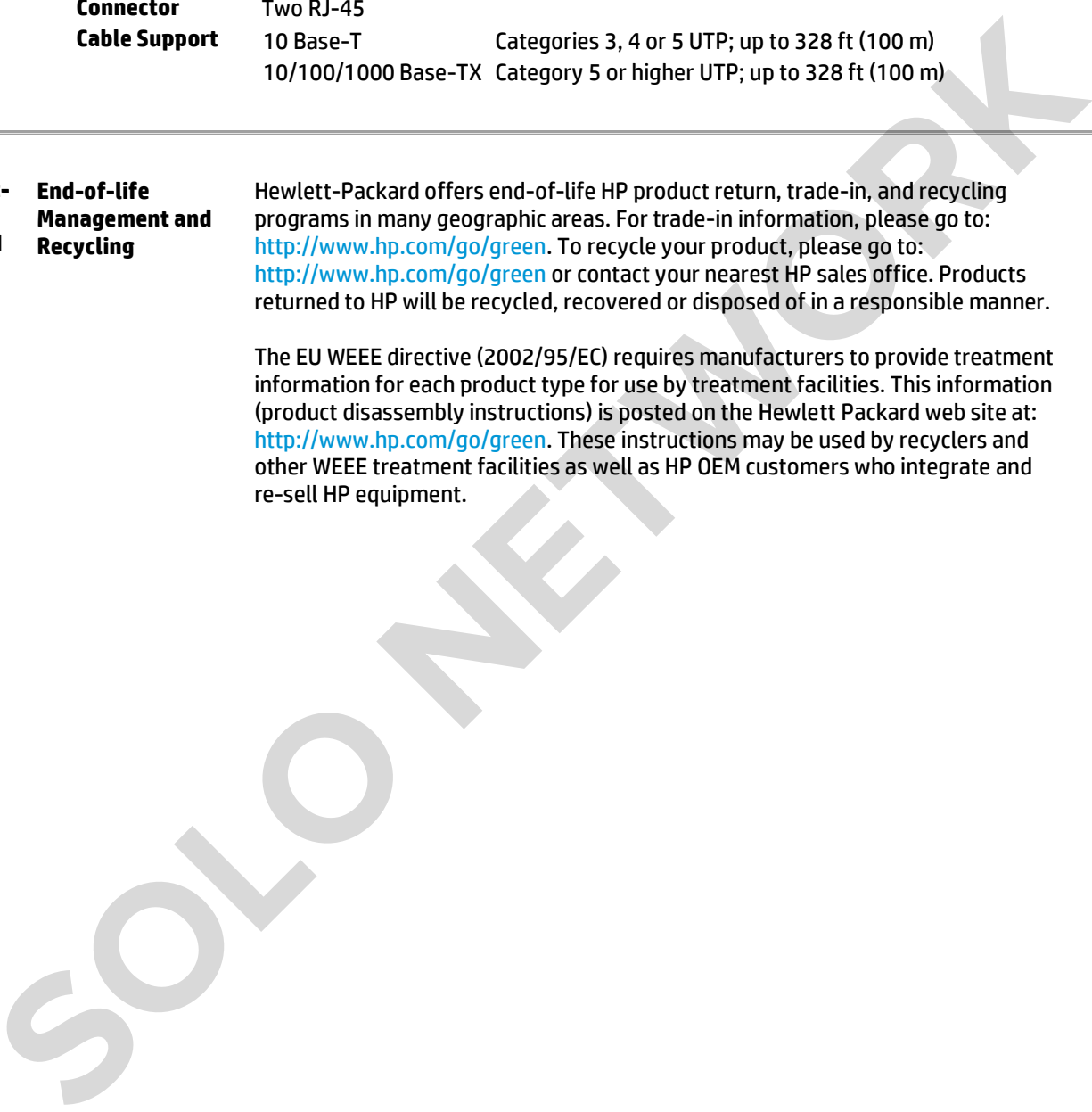

# QuickSpecs

## HP ProLiant DL180 Generation9 (Gen9)

### Summary of Changes

Date	Version History	Action	Description of Change
28-Sep-2015	From Version 8 to 9	Added	Added new 6Gb SATA Solid State Drives. Added new HP OneView management software.
		Removed	Obsolete SKUs were removed from the QuickSpecs.
17-Aug-2015	From Version 7 to 8	Added	New Solid State Drives offering was added to Core Options.
		Changed	Maximum Internal Storage was revised.
		Removed	Obsolete SKUs were removed from the QuickSpecs.
1-Jun-2015	From Version 6 to 7	Added	New Hard Drives offering. New HP OneView licenses added to HP Converged Infrastructure Management Software. New RDX+ external backup options were added.
		Changed	Maximum Internal Storage was revised. Core options and Additional Options were revised.
		Removed	Obsolete SKUs were removed from the QuickSpecs.
30-Mar-2015	From Version 5 to 6	Added	New Hard Drives offering. Optional Software added to HP Storage Controllers.
		Changed	HP Memory, HP Power Supplies, HP Storage Controllers, and HP Disk Storage Systems were revised.
9-Feb-2015	From Version 4 to 5	Added	Added Network controller, new HP Drives, and new G4 UPS models.
		Changed	HP Drives, HP Computation and Graphics Accelerators, HP Tape Backup, HP Disk Backup, HP Rack Mount Consoles, KVM Switches, and Keyboards, HP Uninterruptible Power Systems (UPS), HP Networking, and HP Power Distribution Units (PDUs) sections were revised.
1-Dec-2014	From Version 3 to 4	Changed	Changes made throughout the entire QuickSpecs.
13-Oct-2014	From Version 2 to 3	Added	6G SATA Enterprise Value G1 Solid State Drives were added to Core Option section. HP PCIe Workload Accelerator Options, HP USB and SD options were added to the Additional Options section.
		Changed	Standard Features, Optional Features, Configuration Information - Factory Integrated Models, and Memory sections were revised. Warranty was revised in Standard Features section.
19-Sep-2014	From Version 1 to 2	Changed	Changes made throughout the entire QuickSpecs.



[hp.com/qref/dl180gen9](http://hp.com/qref/dl180gen9)

## Summary of Changes

© Copyright 2015 Hewlett-Packard Development Company, L.P.

The information contained herein is subject to change without notice. The only warranties for HP products and services are set forth in the express warranty statements accompanying such products and services. Nothing herein should be construed as constituting an additional warranty. HP shall not be liable for technical or editorial errors or omissions contained herein.

Intel® and Xeon® are registered trademarks of Intel Corporation in the U.S. and other countries.

Microsoft®, Windows®, and Windows Server® are U.S. registered trademarks of the Microsoft group of companies.

For hard drives, 1GB = 1 billion bytes. Actual formatted capacity is less

SOLO NETWORK